

臥式端吸泵

HORIZONTAL END SUCTION PUMP



联系我们

| WWW.U-FLO.CN

营销中心 Marketing Center

ADD: 南京市江宁区清水亭西路51号-南京俊杰科创大厦9楼 (211102)

Floor No.9, Nanjing Junjie Kechuang Building, No.51 Qingshui Ting West Road, Jiangning District, Nanjing (211102).

TEL: (86) 25-52231105 / 52230907 / 52230921 / 84846376 FAX: (86) 25-52230912

生产中心 Production Center

ADD: 南京市溧水经济开发区南区罗马工业园18号 (211200)

18# Rome Industry Park, Southern District, Lishui Economic Development Zone, Nanjing

TEL: (86) 25-56610801 / 56610802 / 56610803 / 56610805 / 56610815 FAX: (86) 25-56610806

销售服务热线: 400-100-8486 售后服务热线: 400-108-8170

南京方卓品牌设计 | www.njzad.com

PFH/PFHC
HORIZONTAL
END SUCTION
PUMP



Contents 目录

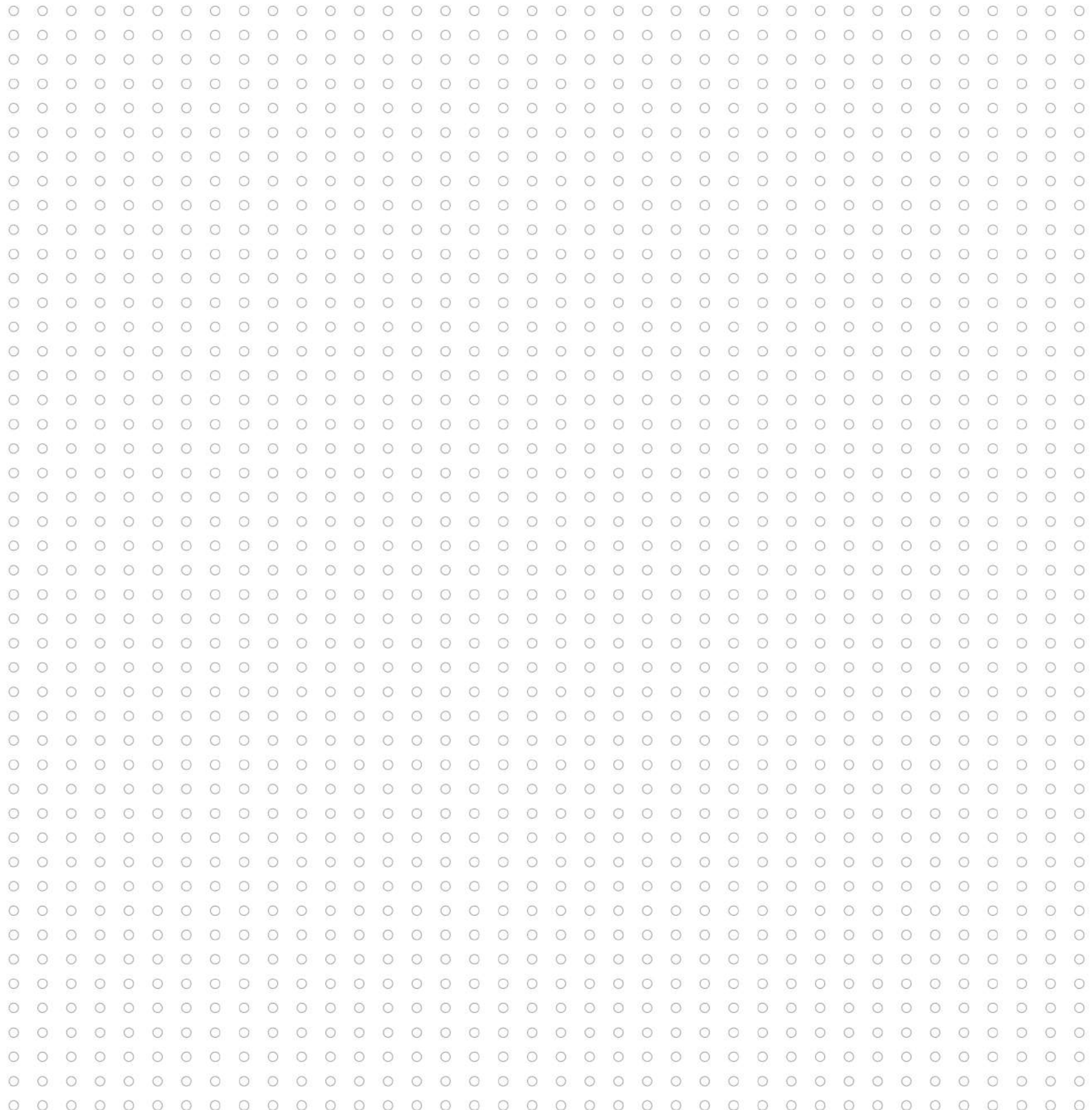

03/04 COMPANY PROFILE 公司介绍

U.S. U-flo
美国尤孚

05/62 PRODUCTS 产品介绍

PFH SERIES
卧式端吸泵 PFH系列
PFHC SERIES
卧式端吸泵 PFHC系列

62/43 OTHERS 其他

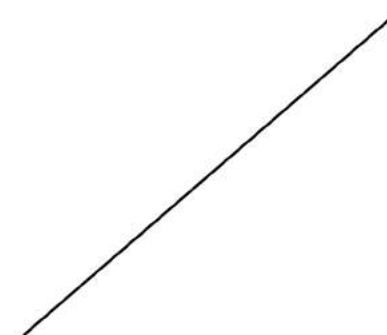



Quality In The Water



U-FLO U.S. 美國尤孚

U-flo Pumps International LLC is a global water pump manufacturing and marketing company registered in Washington, USA. Our cooperated manufacturing facilities are located in Italy, Taiwan and China. Our primary products include Deep-well Pumps, Above-ground Pumps, Sewage Pumps, Pumping Systems. They are widely used in power plants, paper mills, steel plants, agriculture irrigations, construction trades, industrial applications, mining operations, municipal utilities as well as oil/gas fields.

Integrity, Innovation, International

Since the first U-FLO water pump was manufactured, our people have been making unremitting endeavor to improve designs of the U-FLO water pump products. We apply the best industry practices and the best suitable materials for key components to the design and manufacturing of our pumps.

In addition to our state of art manufacturing facilities, we put a big effort on pump testing. Every product undergoes a rigorous testing and inspection process before being shipped to our customers. Our test facility incorporates a 12000 cubic meter (52,834 gallon) closed loop system with testing capacity of up to 600m³/h (2640GPM) with the maximum head of 200m (656ft), and 250 horsepower (dual voltages of 50Hz and 60Hz). Following a strict quality management system, all of our facilities are ISO 9001 and ISO 4001 certified.

Water is a vital part of our natural resources. While we always pursue the excellence of our products and services, we also take every step to promote environment-friendly and energy-saving solutions.

As a global pump manufacturer and supplier, U-FLO is committed to producing the finest water pumps in the world and continues to lead the way forward in the pumping industry.

U-flo 泵业国际有限公司是一家注册于美国华盛顿州的全球化水泵制造销售公司。我们在意大利、中国台湾和中国大陆均有合作制造工厂。我们主要产品包括深井泵、地面泵、污水泵和供水设备。产品广泛应用于电厂、造纸厂、钢厂、农业灌溉、建筑、工业应用、矿山、市政以及油田领域。

诚信、创新、国际化

自第一台 U-flo 水泵出厂以来，我们一直不懈努力，致力于改进 U-flo 水泵的设计。我们以最高的行业要求和最佳材料设计和制造水泵。

在严抓工艺水平的同时，我们还致力于水泵的测试。每一台水泵在出厂前均需要经过严格的测试和检验。我们的测试台含 12000 立方米 (52,834 加仑) 闭式循环系统，最大测试流量达 600m³/h(2640GPM)，最高扬程为 200m(656ft)，250 马力 (双电压 50Hz、60Hz)。按照严格的质量管理体系，我们所有的工厂均通过 ISO9001 和 ISO14001 认证。

水是自然资源的重要组成部分，我们在追求卓越的产品和服务的同时，亦在努力推广环保和节能解决方案。

作为全球水泵制造商和供应商，U-flo 致力于生产全球最好的水泵，成为水泵行业的领跑者。



Quality witness responsibility Technology create reliability

品质见证责任 专业成就信赖!

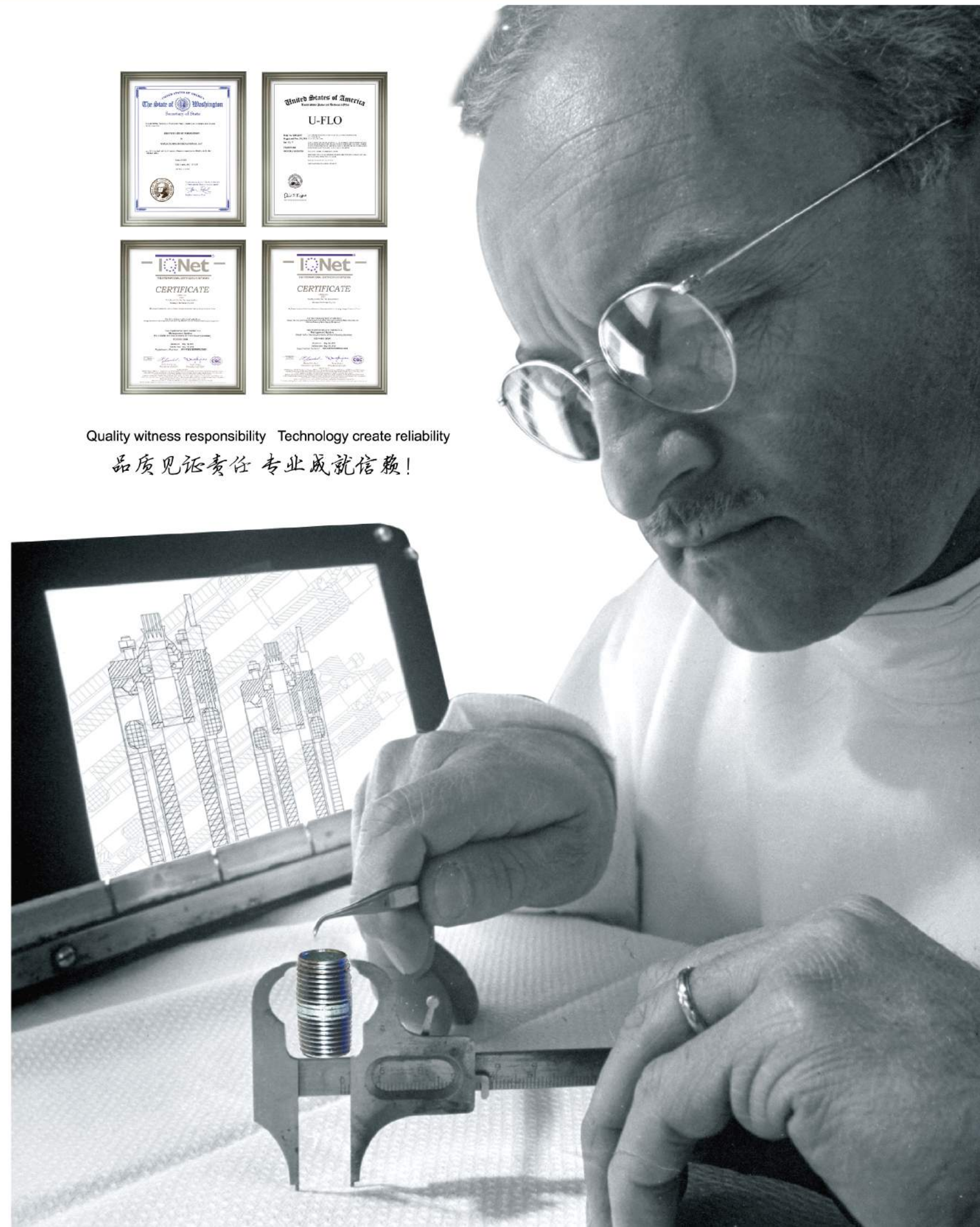

Design & production 设计和制造

Design and production are all made internally at U-flo's facilities, with a quality and process systems in accordance to the ISO9001 standards; as a further results of its environmental orientation, U-flo, in the 2011, got the ambitious ISO14001 Certificate proving that its production processes comply with the very strict rules imposed by the ISO14001 Certificate.

U-flo自主设计和制造，质量及生产系统符合ISO9001标准。更因为U-flo准确的环境定位，2011年获得ISO14001认证，充分证明生产过程符合ISO14001标准。

Product application scope 产品应用范围

Suction pump in the horizontal the following application field, and many use, such as conventional water treatment, industrial, construction, liquid transportation, agriculture irrigation, etc.

卧式端吸泵在下列应用领域中越来越多地使用，如常规的水处理、工业、建筑、液体输送、农业灌溉等领域。

U-FLO reserves the right to make modifications without notice.

U-FLO 有权对产品进行修改，恕不另行通知。



HORIZONTAL END SUCTION PUMP series F

Horizontal end suction pump

PFH SERIES



I、Introduction

PFH horizontal centrifugal pump is widely used in the following application, such as conventional water treatment, industrial, construction, liquid transportation, agriculture irrigation, etc. "U-FLO" PFH horizontal centrifugal pump has been created for years. The accumulation of experience, the concentration on R&D, outstanding quality and advanced manufacturing technology guarantee our strict production demands.

PFH卧式离心泵在下列应用领域中越来越多地使用，如常规的水处理、工业、建筑、液体输送、农业灌溉等领域。

"U-FLO" 卧式离心泵至今已有多年历史，不断积累的经验、在研发上的倾注、优异的质量和最先进的制造技术，无疑是满足生产要求的重要保障。

HORIZONTAL END SUCTION PUMP

PFH SERIES / 卧式端吸泵 PFH/PFHC系列

II、CHARACTERISTICS 特点

1. Adopt single stage single suction pump, axial inlet, radial outlet, the casing bottom is fixed with the base.
 2. Integrated pump shaft adopts oil lubricated guiding deep groove ball bearing.
 3. The pump and motor is connected with semi-flexible or flexible membrane coupling.
 4. Standard type sealing for long life, wear resistant mechanical seal.
 5. Adopt back-pull structure which can achieve maintenance without dismantling pump casing and pipeline.
 6. All pumps use four kinds of shafts, which vastly improves the interchangeability of spare parts, and the shafts use the technique of flame straightening to eliminate the internal stress of shafts and improve the life.
 7. All impellers are available to three cutting, so that it can meet the actual needs of customers.
 8. Wearing rings are installed on both sides of impeller, convenient to maintain and prolong the service life of pump casing and impeller.
 9. The easily disassembling coupling is optional for customers, so convenient to maintain the pump in the circumstance of not moving motor.
1. 水泵采用单级单吸离心泵，轴向进水，径向出水，泵壳底部与底座固定。
 2. 整体式泵轴，采用油脂润滑的导向深水沟球轴承。
 3. 泵与电机之间采用半弹性或弹性膜片式联轴器相连。
 4. 标准型密封为长寿命、耐磨机械密封。
 5. 采用后拉式结构，维修时无须拆除泵壳及管路。
 6. 所有泵采用4种泵轴，极大地提高零件的互换性，且轴采用火焰校直，消除轴内部应力，提高了轴的寿命。
 7. 所有叶轮均可经过三次切削，以满足客户的实际需要。
 8. 叶轮前后均有耐磨口环，方便水泵的维护，提高了泵壳和叶轮的使用寿命，对长时间维持水泵的高效率提供了保证。
 9. 可选配易拆卸联轴器，方便客户在不移动电机的情况下，对水泵进行维护。

III、TECHNICAL SPECIFICATION 技术参数

Flow	流量:Q	≤1900m ³ /h(527L/S)
Head	扬程:H	≤265m
The temperature of the medium	介质温度: T	-30°C至+140°C
Working pressure	工作压力: P	16bar或25bar或32bar
Inlet Diameter	进水口径	最大: DN350
Outlet Diameter	出水口径	最大: DN300

注：如需大流量，高扬程卧式泵，请咨询U-flo公司

IV、MODEL NUMBER 型号说明

PFH 150-400/2-C/C	Pump model	U-flo卧式离心泵
150	Outlet diameter	出水口径(mm)
400	Impeller diameter	叶轮直径(mm)
2	2.2-pole motor 4.4-pole motor	2.2极电机, 4.4极电机
C/C	C/C, C/S, Q/S, C/B, B/B, S/S, N/N	指泵体材质选择

HORIZONTAL END SUCTION PUMP

PFH/PFHC SERIES / 卧式端吸泵
PFH/PFHC系列

V、MATERIALS 材质

HORIZONTAL END SUCTION PUMP - CAST IRON VERSION - CAST IRON/STAINLESS STEEL VERSION

	DESCRIPTION	C/C	C/S
1	Pump body	Cast Iron	Cast Iron
2	Pump cover	Cast Iron	Cast Iron
3	Impeller	Cast Iron	304S.S
4	Sealing ring	Cast Iron	304S.S
5	Shaft	S.S	S.S
6	Sleeve	S.S	S.S
7	Shaft protective sleeve	S.S	S.S
8	Bearing bracket	Cast Iron	Cast Iron

HORIZONTAL END SUCTION PUMP -NODULAR CAST IRON/STAINLESS STEEL VERSION

	DESCRIPTION	Q/S
1	Pump body	Nodular cast iron
2	Pump cover	Cast Iron
3	Impeller	S.S
4	Sealing ring	Cast Iron
5	Shaft	S.S
6	Sleeve	S.S
7	Shaft protective sleeve	S.S
8	Bearing bracket	Cast Iron

HORIZONTAL END SUCTION PUMP - CAST IRON/TIN BRONZE VERSION - ALL TIN BRONZE VERSION

	DESCRIPTION	C/B	B/B
1	Pump body	Cast Iron	Tin bronze
2	Pump cover	Cast Iron	Tin bronze
3	Impeller	Tin bronze	Tin bronze
4	Sealing ring	Cast Iron	Tin bronze
5	Shaft	S.S	DUPLEX Stainless Steel
6	Sleeve	S.S	S.S
7	Shaft protective sleeve	S.S	S.S
8	Bearing bracket	Cast Iron	Cast Iron

HORIZONTAL END SUCTION PUMP - 304 stainless steel version - 316 stainless steel version

	DESCRIPTION	S/S	N/N
1	Pump body	304S.S	Cast Iron
2	Pump cover	304S.S	Cast Iron
3	Impeller	304S.S	316 S.S
4	Sealing ring	304S.S	316 S.S
5	Shaft	DUPLEX Stainless Steel	DUPLEX Stainless Steel
6	Sleeve	304S.S	316S.S
7	Shaft protective sleeve	304S.S	316S.S
8	Bearing bracket	Cast Iron	Cast Iron

HORIZONTAL END SUCTION PUMP

PFH/PFHC SERIES / 卧式端吸泵
PFH/PFHC系列

V、MATERIALS 材质

PFH/PFHC型端吸泵-铸铁型-铸铁/不锈钢型

	名称	C/C	C/S
1	泵体	铸铁	铸铁
2	泵盖	铸铁	铸铁
3	叶轮	铸铁	不锈钢304
4	密封环	铸铁	不锈钢304
5	轴	不锈钢	不锈钢
6	轴套	不锈钢	不锈钢
7	轴保护套	不锈钢	不锈钢
8	轴承托架	铸铁	铸铁

PFH/PFHC型端吸泵-球墨铸铁/不锈钢型

	名称	Q/S
1	泵体	球墨铸铁
2	泵盖	铸铁
3	叶轮	不锈钢
4	密封环	铸铁
5	轴	不锈钢
6	轴套	不锈钢
7	轴保护套	不锈钢
8	轴承托架	铸铁

PFH/PFHC型端吸泵-铸铁/锡青铜型-全锡青铜型

	名称	C/B	B/B
1	泵体	铸铁	锡青铜
2	泵盖	铸铁	锡青铜
3	叶轮	锡青铜	锡青铜
4	密封环	铸铁	铅青铜
5	轴	不锈钢	双相不锈钢
6	轴套	不锈钢	不锈钢
7	轴保护套	不锈钢	不锈钢
8	轴承托架	铸铁	铸铁

PFH/PFHC型端吸泵-全304不锈钢型-全316不锈钢型

	名称	S/S	N/N
1	泵体	不锈钢304	铸铁
2	泵盖	不锈钢304	铸铁
3	叶轮	不锈钢304	不锈钢316
4	密封环	不锈钢304	不锈钢316
5	轴	双相不锈钢	双相不锈钢
6	轴套	不锈钢304	不锈钢316
7	轴保护套	不锈钢304	不锈钢316
8	轴承托架	铸铁	铸铁

PFH

PFHC

PFH/PFHC32

PFH/PFHC40

PFH/PFHC50

PFH/PFHC65

PFH/PFHC80

PFH/PFHC100

PFH/PFHC125

PFH/PFHC150

PFH/PFHC200

PFH/PFHC250

PFH/PFHC300

OTHERS

HORIZONTAL END SUCTION PUMP

PFH SERIES / 卧式端吸泵
PFH/PFH系列

VI、COMPONENTS 组件

1. IMPELLER

The impeller of this type of pumps is closed axial impeller. With balance pipe in its back, smooth surface and the high-precision size of machining, it can ensure a good balance, and the customers can select the operating point of the impeller according to their needs.

1. 叶轮

该类型泵的叶轮为密闭轴向型叶轮，背部有平衡孔，表面平滑，加工的尺寸高度精确，并保证具有良好的平衡，可根据客户的需要选择叶轮的工作点。



2. SHAFT SEAL

PFH series pumps are equipped with a free to maintain the balance of the carbon/tungsten carbide mechanical seal, valve screw channel to the circulation of the liquid to ensure shaft seal lubrication and cooling. Meet EN12756 standard mechanical seal.

2. 轴密封

PFH系列泵都装有一只免维护非平衡性碳/碳化钨的机械密封，气门螺塞通道中液体的循环确保轴封润滑和冷却。符合EN12756标准的机械密封。

3. SHAFT & BEARING BOX

Shaft and bearing box: The increasing Heating Intensity of shaft through heat treatment, high-precision mechanical surface and reasonable size improve its service life. The bearing bracket assembly includes two long-life grease deep groove ball bearings, and it is made of cast iron JL1040, shaft C45 steel or stainless steel 1.4057/1.4462 and other materials. With a water control ring on the shaft, it can prevent fluid from entering the bearing cavity and there is a stainless steel sleeve to protect bearings in the bearings of the gland packing seal.

3. 轴及轴承箱

轴经过热处理加热强度，表面高精度加工，尺寸合理，有效提高使用寿命。轴承托架组件包括两只油脂润滑的长寿命深沟球轴承，轴承托架材质为铸铁JL1040，轴C45钢或者为不锈钢1.4057、1.4462等材质，轴上配有控水圈以防止液体进入轴承腔，填料密封型在轴处有一个不锈钢套保护泵轴。

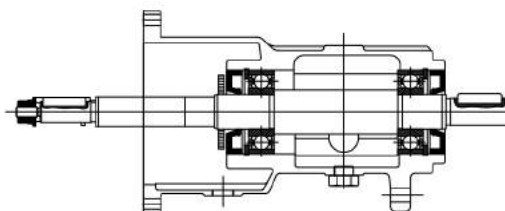

4. MOTOR

Surface Cooled IEC Three-phase Squirrel Cage motor Power: 3.7-355KW Installation: IM B3 IM B35
Frequency: 50Hz/60Hz Insulation Class: F/B Operation Mode: Continuous operation Temperature: up to 40°C

4. 电机

表面冷却的IEC三相鼠笼式电机 电机功率：3.7-355KW 安装方式IM B3 IM B35 频率：50HZ/60HZ 绝缘等级：F级/B级 运行模式：持续运行S1 环境温度：最高40°C

5. COUPLING

With/without longer for shaft of the flexible coupling

5. 联轴器

带/不带加长轴段的弹性联轴器

6. Coupling cover shell

Adopt stainless steel cover

6. 联轴器罩壳

采用不锈钢防护罩

STANDARD SCOPE OF SUPPLY

Pump casing: DN32-DN300 Impeller: cast iron, Ductile iron, cast steel, tin bronze, stainless steel Pump cover: cast iron, bronze, stainless steel

Seal: Mechanical seal Motor: Standard Motor Common Base: steel Coupling: Dowel pin type Diaphragm Type

标注供货范围

泵壳：口径从DN32至DN300 叶轮：铸铁、球墨铸铁、铸钢、锡青铜、不锈钢304/316 泵盖：铸铁、青铜、不锈钢304、316
密封：机械密封 电机：有三种型式可选，2、4、6级标准电机 公共底座：钢制 联轴器：柱销型、膜片式

HORIZONTAL END SUCTION PUMP

PFH SERIES / 卧式端吸泵
PFH/PFH系列

VII、STRUCTURE 结构说明

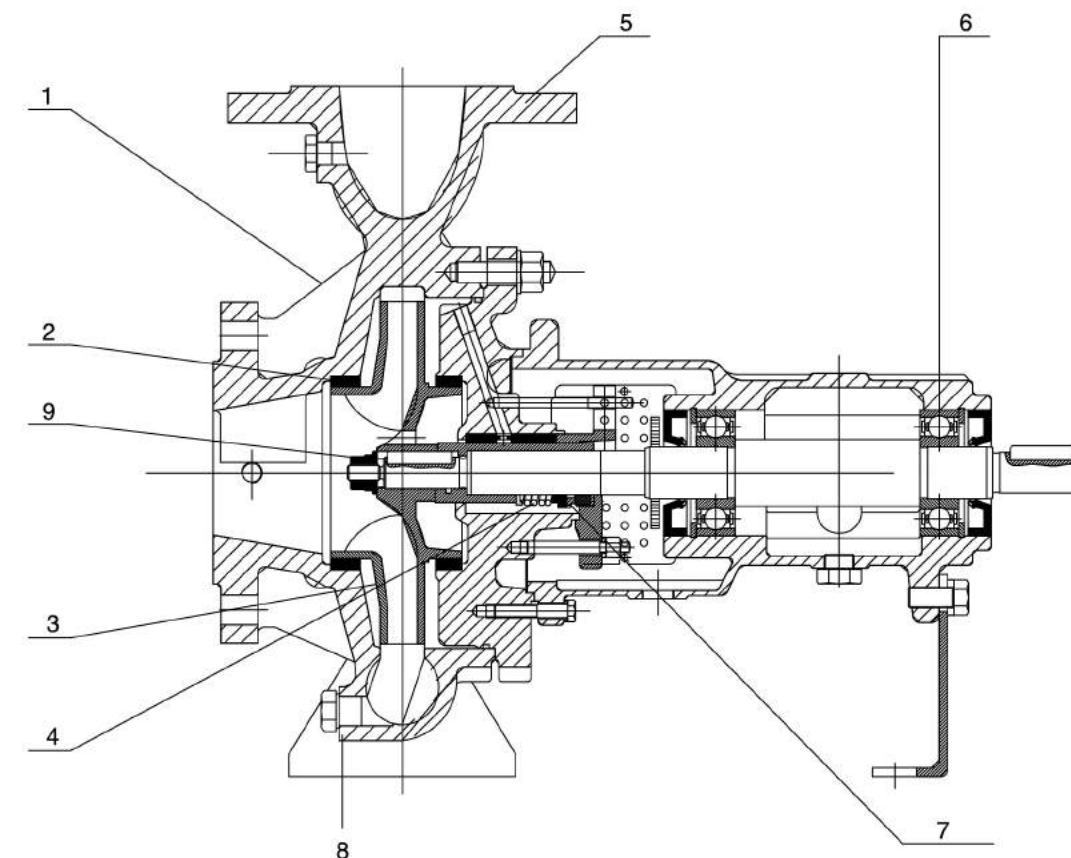

DESCRIPTION	名称
1 A variety of materials to choose from cast iron, nodular cast iron, tin bronze, stainless steel 1.4301(304), stainless steel 1.4401(316)	多种材料可供选择 (铸铁、球墨铸铁、铸铁衬氟、锡青铜、 不锈钢1.4301 (304)、1.4401 (316))
2 Wearing ring	耐磨环 (当间隙磨损过大时, 可更换耐磨环, 确保水泵高效)
3 Impeller	叶轮 (实现了最佳的水力设计效率和QH性能曲线)
4 Seal	密封 (机械密封可根据不同应用选择)
5 Pump casing	泵壳 (设计标准承压1.6Mpa, 最高承压可达3.2Mpa)
6 bearing	轴承 (进口SKF或同等档次轴承, 确保使用寿命)
7 Shaft protective sleeve	轴护套 (防止泵轴磨损加快)
8 Back-shaft design	后轴式设计 (易拆卸, 水泵拆卸时, 无需将管道拆除)
9 Inlet design	进口设计 (设计针对最大进水量和最佳气蚀(NPSH)性能)

HORIZONTAL END SUCTION PUMP series F

Horizontal end suction pump

PFHC SERIES



I、Introduction

The PFHC pump is more and more popular in the following applications, such as conventional industrial water treatment, high-rise water supply, general industrial water, fire water supply, construction water supply, agricultural irrigation, boiler feed water and other fields.

"U-FLO" PFHC horizontal centrifugal pump has been created for years. The accumulation of experience, the concentration on R&D, outstanding quality and advanced manufacturing technology guarantee our strict production demands.

PFHC卧式直联泵在下列应用领域中越来越多地使用，如常规的工业水处理、高楼给水、一般工业用水、消防给水、土木施工给水、农业灌溉、锅炉给水等领域。

"U-FLO" 卧式直联泵至今已有多年历史，不断积累的经验、在研发上的倾注、优异的质量和最先进的制造技术，无疑是满足生产要求的重要保障。

HORIZONTAL END SUCTION PUMP

PFHC SERIES / 卧式端吸泵 PFH/PFHC系列

II、CHARACTERISTICS 特点

1. Impeller adopts advanced hydraulic model design, has good static and dynamic balance and stable performance.
2. Pump shaft and motor adopt direct connected structure, which has reliable concentricity.
3. Adopt SKF bearing, small vibration and low noise.
4. Closed impeller and pump casing.
5. High efficiency, small in size, light in weight, easy to install and maintain.
6. Adopt mechanical seal, prevent bearing damage and water leakage. Long service life.
7. ISO 2858、ISO 5199 International standard, the same performance equivalence with the products which comply with the requirements of the standard. With those advantage: the interchangeability of the connection of the pump casing, the shorter size of shaft and less area covering.
8. Quality improved structure design: adopt high efficiency volute pump casing
 - (1) Single end mechanical seal, suitable for no leakage application.
 - (2) Pump and motor are direct connected by support, simple and compact.
 - (3) Impeller balance: static balance to satisfy normal requirement, dynamic balance to meet the strict vibration control situation.
9. Different materials are available as required.
 1. 叶轮采用优秀水力模型设计，具有极好的动静平衡，性能稳定。
 2. 泵轴与电机采用直联式结构，同心度绝对可靠。
 3. 整体泵采用进口SKF轴承、振动小、噪音低。
 4. 单级、单吸卧式离心泵，采用闭式叶轮及蜗壳。
 5. 同轴直接式构造、效率高、体积小、重量轻、易于安装及维护。
 6. 采用机械密封、保证不损轴心、不漏水、使用寿命长。
 7. 符合ISO2858、ISO5199国际标准-与其他符合该标准要求的产品具有性能等同性及泵壳联接的互换性，且轴向尺寸更短，占地面积更少。
 8. 提升质量的结构设计：泵体-采用高效能的泵壳形式，其法兰符合GB/T 17241.6-1998PN1.6MPa(16bar),并可与下列标准同级法兰配合使用：BS4504-1989,ISO 7005.1-1992、DIN2533-1976、ISO7005.2-1988；
 - (1) 单端面机械密封，适合不泄漏的场合
 - (2) 泵与电机通过直联架直接连接，结构简单紧凑
 - (3) 叶轮平衡：叶轮通常进行静平衡即能满足使用要求，而对振动控制比较严格的使用场合，则进行动平衡处理
 9. 可根据要求采用不同材质；

III、TECHNICAL SPECIFICATION 技术参数

Capacity	流量:Q	450m ³ /h
Head	扬程:H	160m
The temperature of the medium	介质温度: T	-20°C至+140°C
Working pressure	工作压力: P	16bar或25bar

IV、MODEL NUMBER 型号说明

PFHC 100 - 200/4-C/C	Horizontal Direct - connected	U-flo卧式直联泵
100	Outlet diameter	出水口直径(mm)
200	Impeller diameter	叶轮直径(mm)
4	2.2-pole motor 4.4-pole motor	2.2极电机, 4.4极电机
C/C	C/C, C/S, Q/S, C/B, B/B, S/S, N/N	指泵体材质选择

HORIZONTAL END SUCTION PUMP

PFHC SERIES / 卧式端吸泵
PFH/PFHC系列

V、STRUCTURE 结构说明

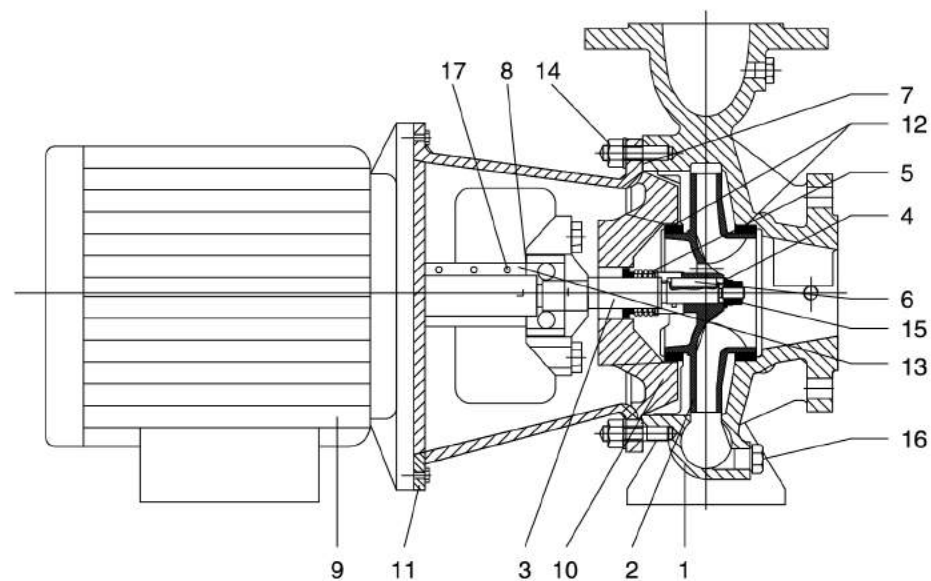

DESCRIPTION	名称
1 Pump body	泵体
2 Impeller	叶轮
3 Shaft	轴
4 Impeller washer	叶轮垫圈
5 Mechanical seal	机械密封
6 Key	键
7 O-ring	O形密封圈
8 Flexible washer	弹性垫圈
9 Motor	电机
10 Pump cover	泵盖
11 Direct connection support	直联架
12 Sealing ring	密封环
13 Motor jacket	电机夹套
14 Connection bolt	联接螺栓
15 Impeller nut	叶轮螺母
16 Hexagonal bolt	六角螺塞
17 Hex socket bolt	内六角螺塞

HORIZONTAL END SUCTION PUMP

PFH/PFHC SERIES / 卧式端吸泵
PFH/PFHC系列

VI、PERFORMANCE CURVE DIAGRAM 型谱图

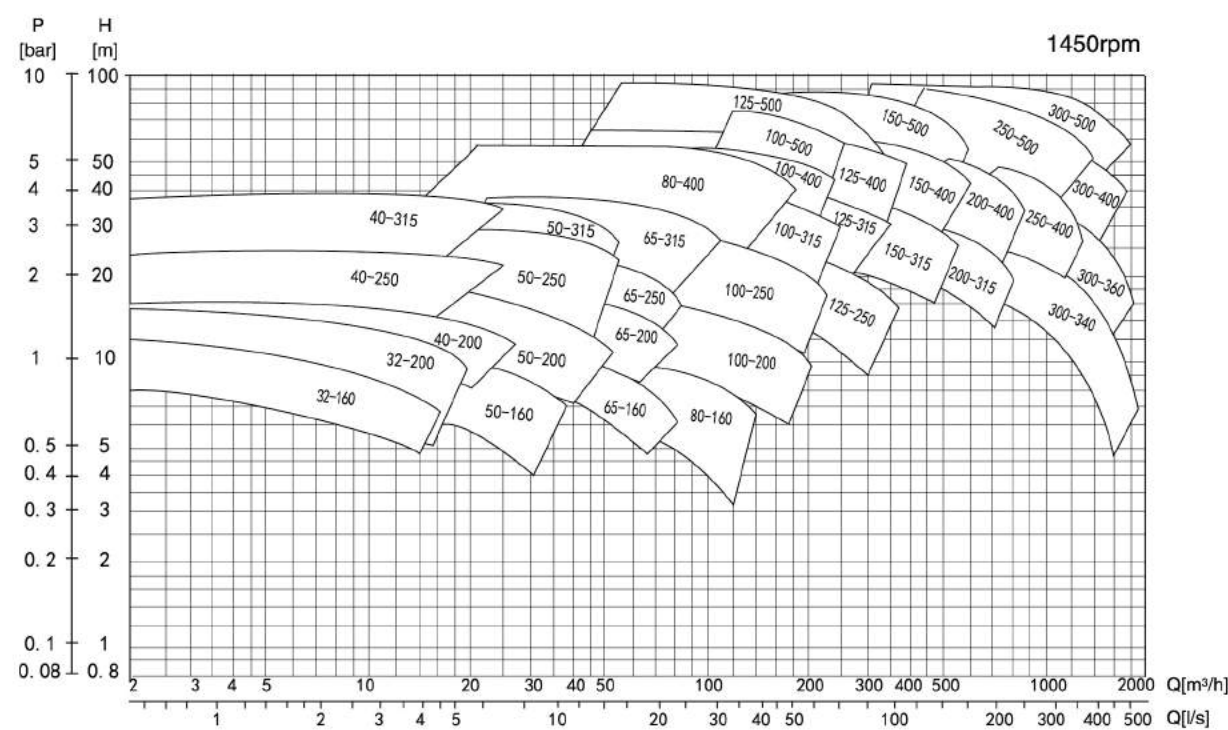
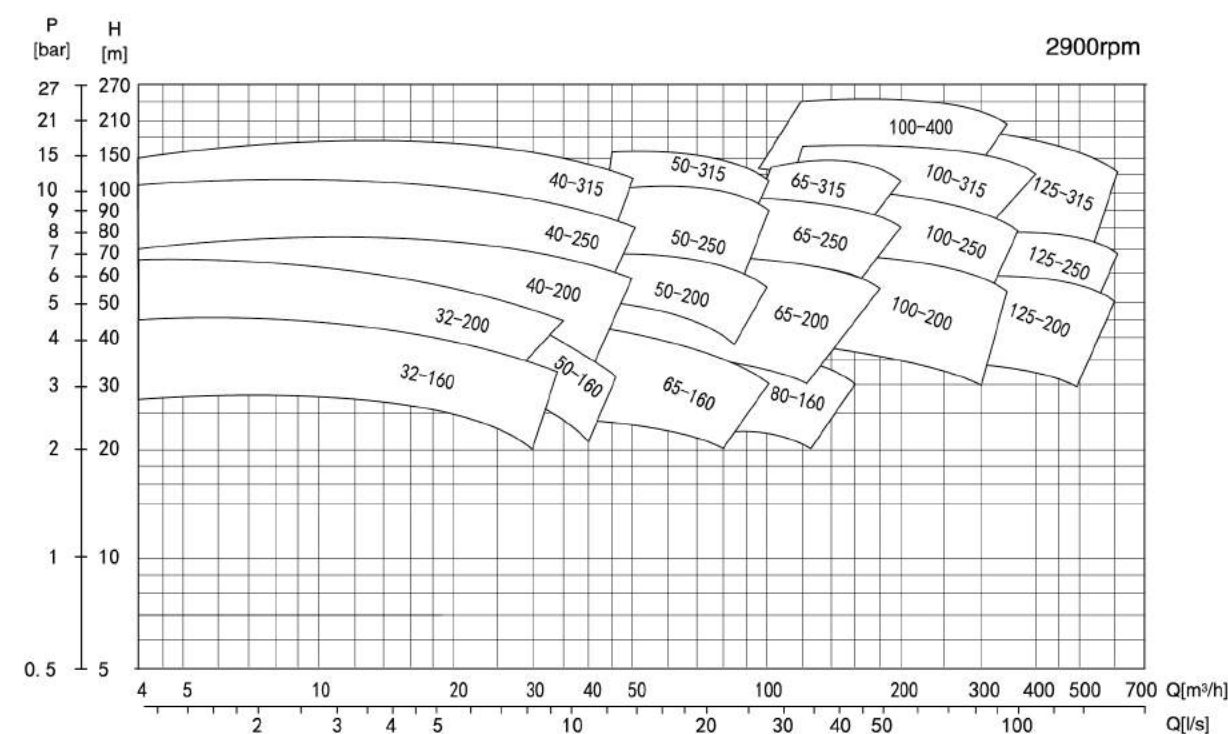

- PFH
- PFHC
- PFH/PFHC32
- PFH/PFHC40
- PFH/PFHC50
- PFH/PFHC65
- PFH/PFHC80
- PFH/PFHC100
- PFH/PFHC125
- PFH/PFHC150
- PFH/PFHC200
- PFH/PFHC250
- PFH/PFHC300
- OTHERS

HORIZONTAL END SUCTION PUMP

PFH/PFHC SERIES / 卧式端吸泵
PFH/PFHC系列

VII、APPLICATION & COFIGURATION

Transport medium	Application limit	Materials ⁹⁾ Pump shell/impeller						Shaft seal Mechanical seal						Reference Numbers Packing seal / Mechanical seal		Note	
		Cast Iron/Cast Iron	Cast Iron/Tin bronze	Nodular cast iron /Cast Iron	Tin bronze/Tin bronze	Stainless steel /Stainless steel	RT-P	Graphite	U3BEGG 4)	U3U3X4GG	Q1Q1X4GG	BO1EGG	Q1Q1MMGG	Na.p1 ≤ 0.5bar	Na.p1 ≤ 0.5bar		
																	CC
Water																	Stainless steel can be used
Weak brine ²⁾	t ≤ 25 C; P ≤ 10bar				x		x			x			B1	B10			
Condensate ²⁾	t ≤ 120 C; P ≤ 10bar	x					x				x		G1	G11			
Condensate, no conditions attached	t ≤ 120 C; P ≤ 10bar						x				x		C1	C10			Open cycle, the M1 / M10
Cooling water, (no freezing agent)	t ≤ 60 C ⁷⁾ ; P ≤ 10bar	x					x			x			G1	G11			Open cycle, the M1 / M11
Cooling water, PH7.5 (including coolant) ⁵⁾	t ≤ 120 C; P ≤ 10bar	x					x			x			G1	M10			
Reservoir water ¹⁾	t ≤ 40 C; P ≤ 10bar		x				x			x			B1	B10			If too much solid particles, please contact
Drinking water ¹⁾	t ≤ 60 C ⁷⁾ ; P ≤ 10bar		x				x			x			M1	M10			
Fire water ¹⁾	t ≤ 60 C ⁷⁾ ; P ≤ 10bar		x				x			x			M1	M10			If need to meet the standard Vds, Please contact U-Flo
Water desalination	t ≤ 120 C; P ≤ 10bar					x	x				x		C1	C11			Unable to meet demand purity
As the boiler feed water desalination water ¹⁾	t ≤ 120 C; P ≤ 10bar	x					x			x			G1	G1			
Hot water ²⁾	t ≤ 120 C; P ≤ 10bar	x					x				x		B1	B1			
Hot water ²⁾	t ≤ 140 C; P ≤ 10bar	x						x	x				G3	G6			Circulation pump can do
Part water desalination ²⁾	t ≤ 60 C ⁸⁾ ; P ≤ 10bar		x				x				x		M1	M11			
Pure water ⁶⁾	t ≤ 60 C ⁸⁾ ; P ≤ 10bar	x					x				x		G1	G11			
Lightly polluted water ¹⁾	t ≤ -30 C; P ≤ 10bar t ≤ 110C	x					x			x			G1	G11			
Seawater ³⁾	t ≤ 60 C ⁷⁾ ; P ≤ 10bar	x					x			x			G11	G10			Stainless steel can be used
Raw water ¹⁾	t ≤ 25 C; P ≤ 10bar						x			x			B1	B10			
Swimming pool water (water) ¹⁾	t ≤ 60 C ⁷⁾ ; P ≤ 10bar	x					x			x			G1	G10			The same DIN19463 accord with standard
Swimming pool water (water) ³⁾	t ≤ 60 C; P ≤ 10bar	x					x			x			G1	G10			If ts + 25 stainless steel can be used
Hot water ²⁾	t ≤ 110 C; P ≤ 10bar	x					x			x			G1	G10			
Coolant, cooling salt water																	
Salt water cooling, inorganic PH7.5; Inhibiting the	t ≤ -30 C; P ≤ 10bar t ≤ 25 C	x					x				x		G1	G11			
Containing coolant water PH ≧ 7.5 ^{1) 5)}	t ≤ -30 C; P ≤ 10bar t ≤ 110C	x					x				x		G1	G11			
Oil/emulsions																	
Diesel, gasoline EL	t ≤ 60 C; P ≤ 10bar		x								x		S10				If no special requirements usable gray cast iron
Lubricant, turbine oil, does not apply to the SDF oil (not easy burning)	t ≤ 80 C; P ≤ 10bar		x								x		S10				If request without internal primer, please contact U-Flo. If no special requirements, usable gray cast iron
Oil and water emulsion	t ≤ 60 C; P ≤ 10bar	x								x			G1	G9			
Drilling/grinding emulsions	t ≤ 60 C; P ≤ 10bar	x								x			G1	G9			
Qing agent																	
Wash bottles of wastewater	t ≤ 90 C; P ≤ 10bar	x					x						G1	G7			Q1Q1EGG
Liquor-making industry																	
Malt pulp	t ≤ 100 C; P ≤ 10bar	x									x		G12				If there may be a empty pool, Cause the danger of dry running water pump, Need to set up a tandem double seal
Malt juice	t ≤ 100 C; P ≤ 10bar	x									x		G12				

HORIZONTAL END SUCTION PUMP

PFH/PFHC SERIES / 卧式端吸泵
PFH/PFHC系列

VII、应用领域与配置

输送介质	应用限制	材料 ⁹⁾ 泵壳/叶轮						轴封 填料密封 机械密封						参考编号 填料密封 机械密封		备注		
		铸铁/铸钢	铸钢/铸铜	球墨铸铁/铸铁	铜青铜/铸青铜	不锈钢/铸钢	RT-P	石墨	U3BEGG 4)	U3U3X4GG	Q1Q1X4GG	BO1EGG	Q1Q1MMGG	Na.p1 ≤ 0.5bar	Na.p1 ≤ 0.5bar			
																	CC	CB
水																		不锈钢可用
淡盐水 ²⁾	t ≤ 25 C; P ≤ 10bar				x		x				x		B1	B10				
凝结水 ²⁾	t ≤ 120 C; P ≤ 10bar	x					x				x		G1	G11				
凝结水,无附加条件	t ≤ 120 C; P ≤ 10bar						x				x		C1	C10			开放式循环, 采用M1/M10	
冷却水,(无冷冻剂)	t ≤ 60 C ⁷⁾ ; P ≤ 10bar	x					x				x		G1	G11			开放式循环, 采用M1/M11	
冷却水,PH7.5(含冷冻剂) ⁵⁾	t ≤ 120 C; P ≤ 10bar	x					x				x		G1	M10				
水库水 ¹⁾	t ≤ 40 C; P ≤ 10bar		x				x				x		B1	B10			如固体颗粒过多, 请联系	
饮用水 ¹⁾	t ≤ 60 C ⁷⁾ ; P ≤ 10bar		x				x				x		M1	M10				
消防水 ¹⁾	t ≤ 60 C ⁷⁾ ; P ≤ 10bar		x				x				x		M1	M10			如需要满足Vds标准, 请联系U-flo	
脱盐水	t ≤ 120 C; P ≤ 10bar						x	x				x	C1	C11			纯度要求无法满足	
作为锅炉给水的脱盐水 ¹⁾	t ≤ 120 C; P ≤ 10bar	x					x				x		G1	G1				
热水 ²⁾	t ≤ 120 C; P ≤ 10bar	x					x				x		B1	B1				
热水 ²⁾	t ≤ 140 C; P ≤ 10bar	x						x	x				G3	G6			可做循环泵	
部分脱盐水 ²⁾	t ≤ 60 C ⁸⁾ ; P ≤ 10bar		x				x				x		M1	M11				
纯水 ⁶⁾	t ≤ 60 C ⁸⁾ ; P ≤ 10bar	x					x				x		G1	G11				
轻度污染水 ¹⁾	t ≤ -30 C; P ≤ 10bar t ≤ 110C	x					x				x		G1	G11				
海水 ³⁾	t ≤ 60 C ⁷⁾ ; P ≤ 10bar	x					x				x		G11	G10			不锈钢可用	
原水 ¹⁾	t ≤ 25 C; P ≤ 10bar						x				x		B1	B10				
游泳池用水(淡水) ¹⁾	t ≤ 60 C ⁷⁾ ; P ≤ 10bar	x					x				x		G1	G10			同样符合DIN19463标准	
游泳池用水(海水) ³⁾	t ≤ 60 C; P ≤ 10bar	x					x				x		G1	G10			如果ts+25不锈钢可用	
热水 ²⁾	t ≤ 110 C; P ≤ 10bar	x					x				x		G1	G10				
冷冻剂,冷却盐水																		
冷却盐水,无机的 PH7.5;抑制的	t ≤ -30 C; P ≤ 10bar t ≤ 25 C	x					x				x		G1	G11				
含冷却剂的水 PH ≧ 7.5 ^{1) 5)}	t ≤ -30 C; P ≤ 10bar t ≤ 110C	x					x				x		G1	G11				
油/乳剂																		
柴油,汽油EL	t ≤ 60 C; P ≤ 10bar		x								x		S10				如无特殊要求可用灰铸铁	
润滑油,透平油,不适用于SDF的油(不易燃烧)	t ≤ 80 C; P ≤ 10bar		x								x		S10				如要求无内部涂层, 请联系U-flo, 如无特殊要求, 则可用灰铸铁	
油水乳液	t ≤ 60 C; P ≤ 10bar	x									x		G1	G9				
钻孔/研磨乳剂	t ≤ 60 C; P ≤ 10bar	x									x		G1	G9				
清水剂																		
洗瓶废水	t ≤ 90 C; P ≤ 10bar	x					x						G1	G7			Q1Q1EGG	
酿酒行业																		
麦芽浆	t ≤ 100 C; P ≤ 10bar	x									x		G12				如果有可能出现水池过空, 造成水泵干运转的危险, 需要设置串联式双密封	
麦芽汁	t ≤ 100 C; P ≤ 10bar	x									x		G12					

HORIZONTAL END SUCTION PUMP

PFH/PFHC SERIES / 卧式端吸泵
PFH/PFHC系列

VIII、SELECTION GUIDE 选型指南

假设Q=20m³/h, H=30m

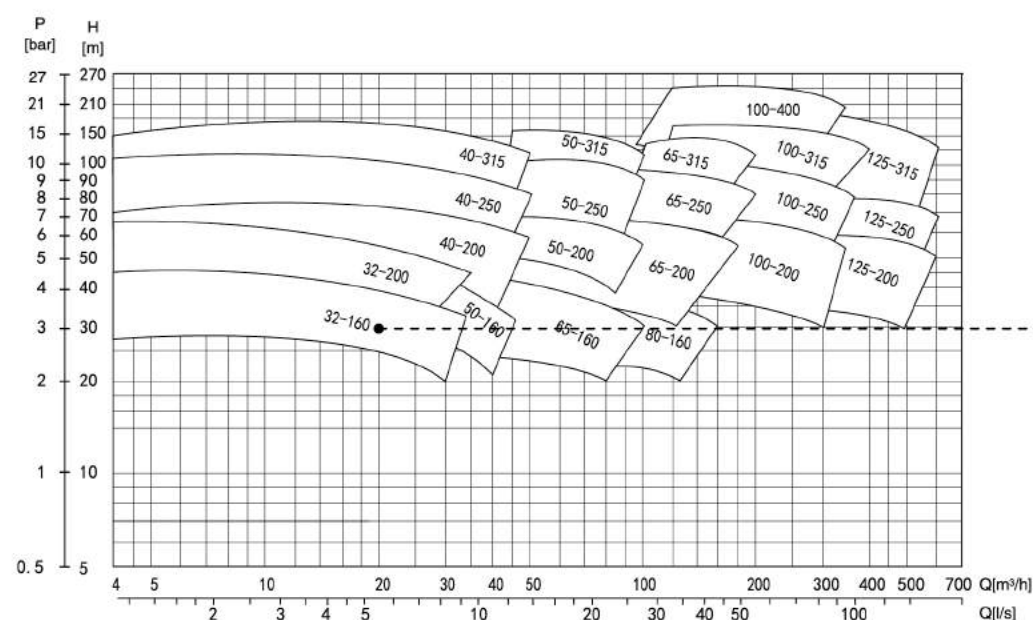

查看行型谱图, 根据参数选择对应的水泵型号然后查看水泵型号的性能曲线图。

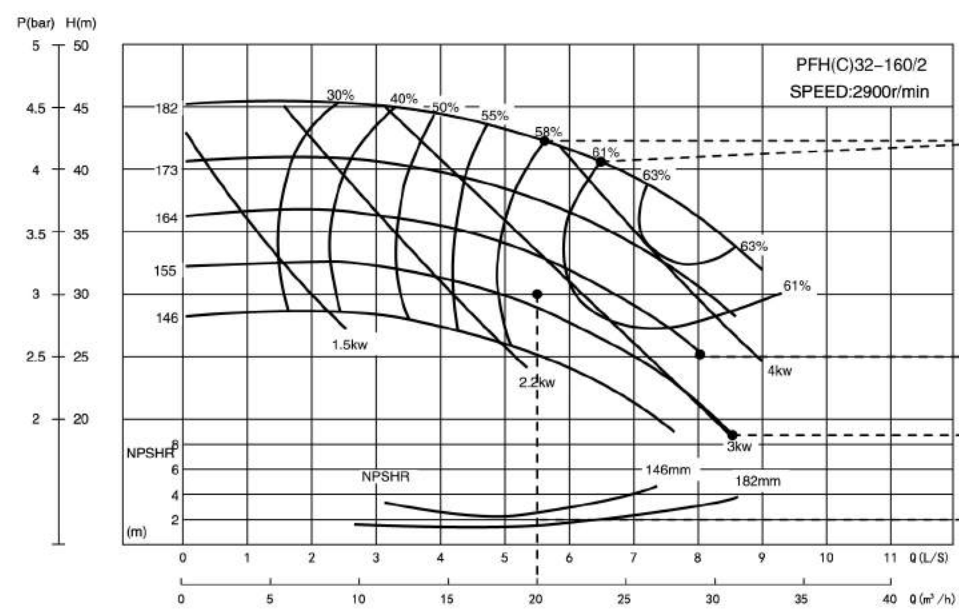

- 确定水泵运行效率
- 确定水泵叶轮直径
- 确定电功率大小
- 确定NPSH值

HORIZONTAL END SUCTION PUMP

PFH/PFHC SERIES / 卧式端吸泵
PFH/PFHC系列

I、PERFORMANCE CURVE CHART 性能曲线图(2900rpm)

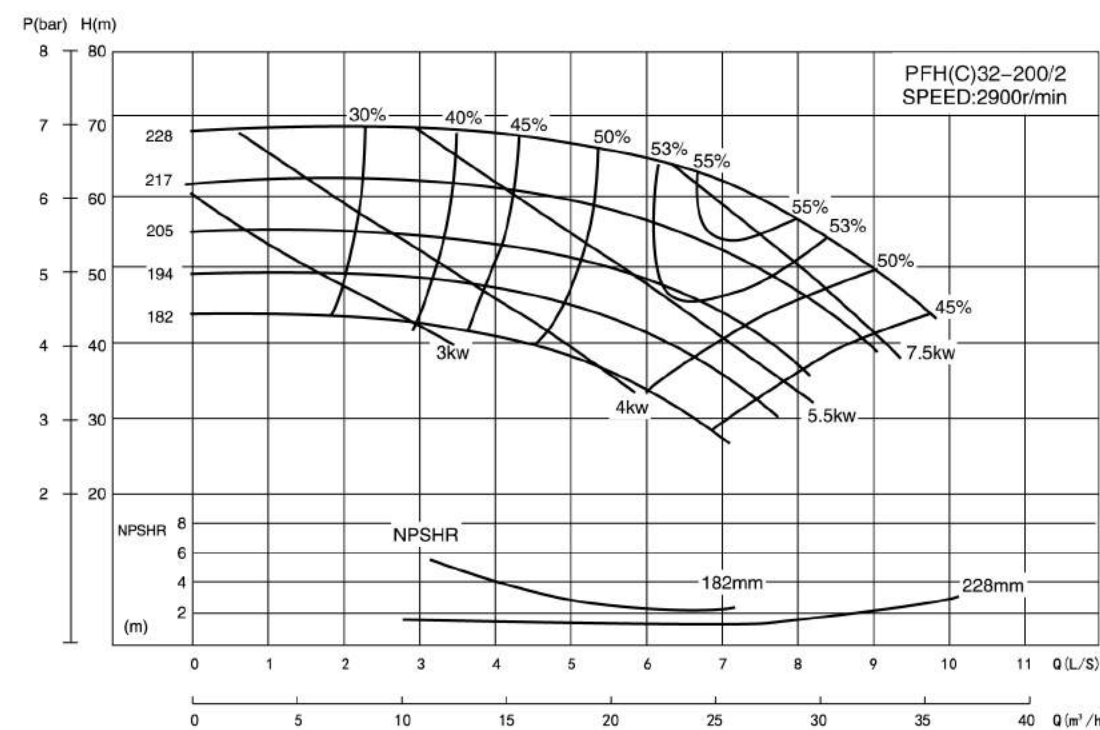
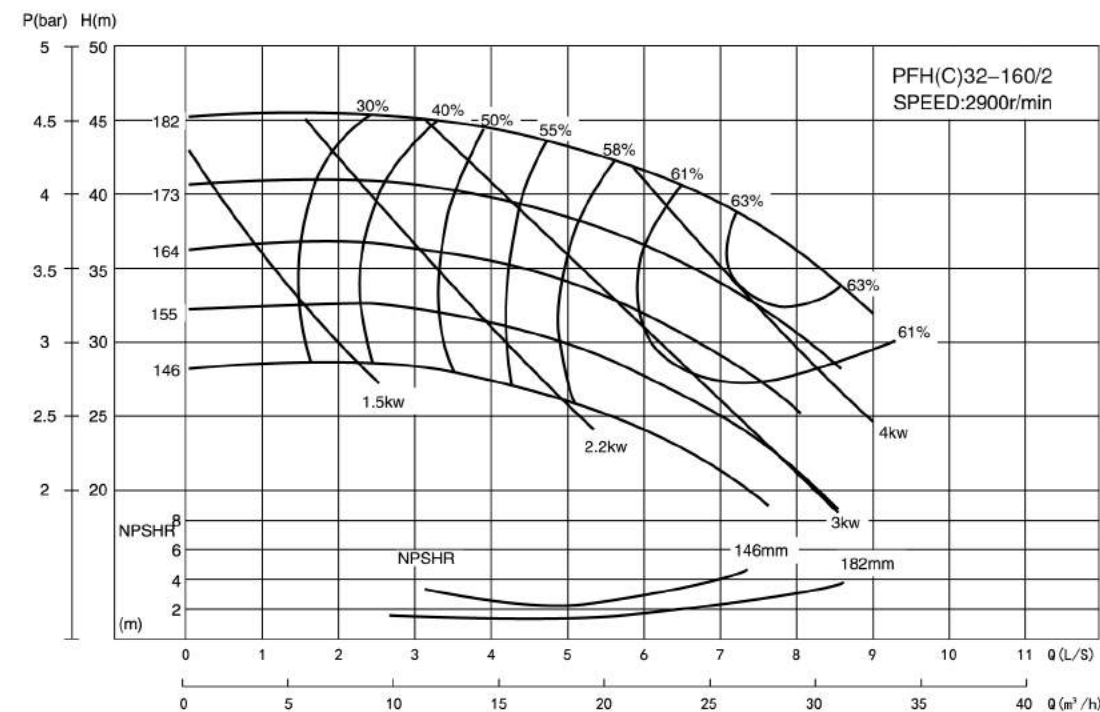

- PFH
- PFHC
- PFH/PFHC32
- PFH/PFHC40
- PFH/PFHC50
- PFH/PFHC65
- PFH/PFHC80
- PFH/PFHC100
- PFH/PFHC125
- PFH/PFHC150
- PFH/PFHC200
- PFH/PFHC250
- PFH/PFHC300
- OTHERS

HORIZONTAL END SUCTION PUMP

PFH/PFHC SERIES / 卧式端吸泵
PFH/PFHC系列

I、PERFORMANCE CURVE CHART 性能曲线图(2900rpm)

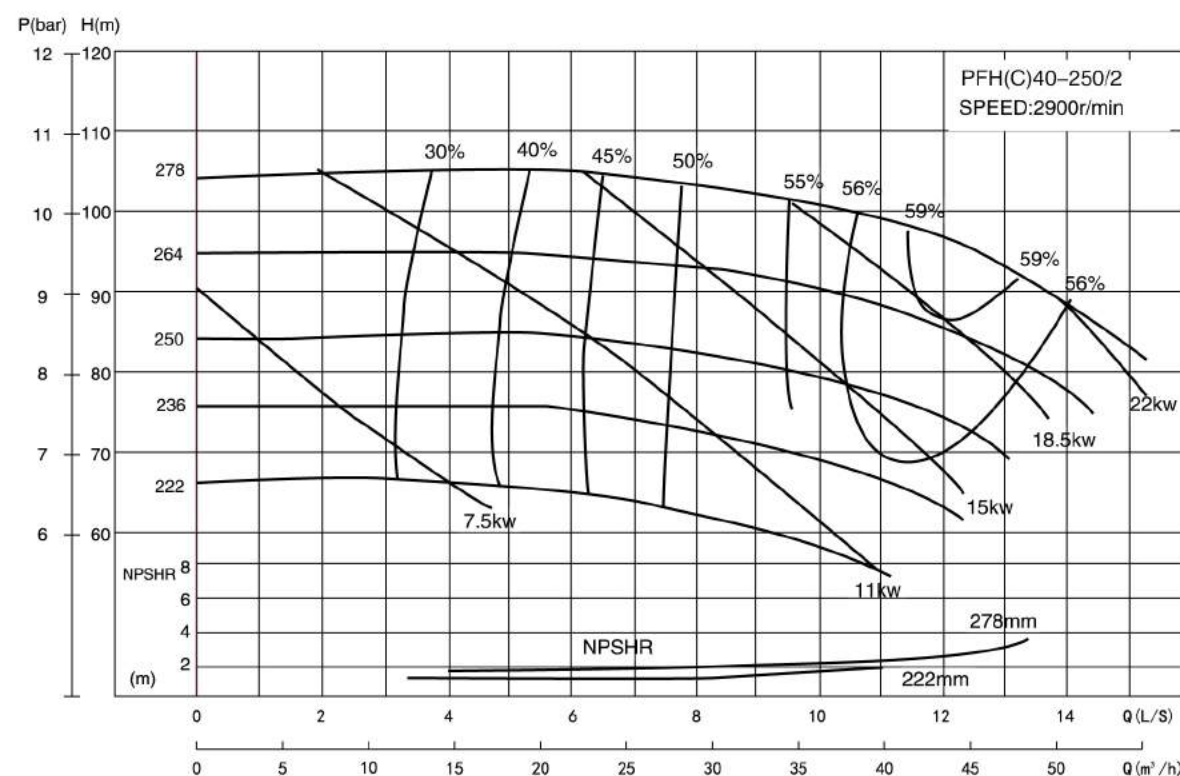
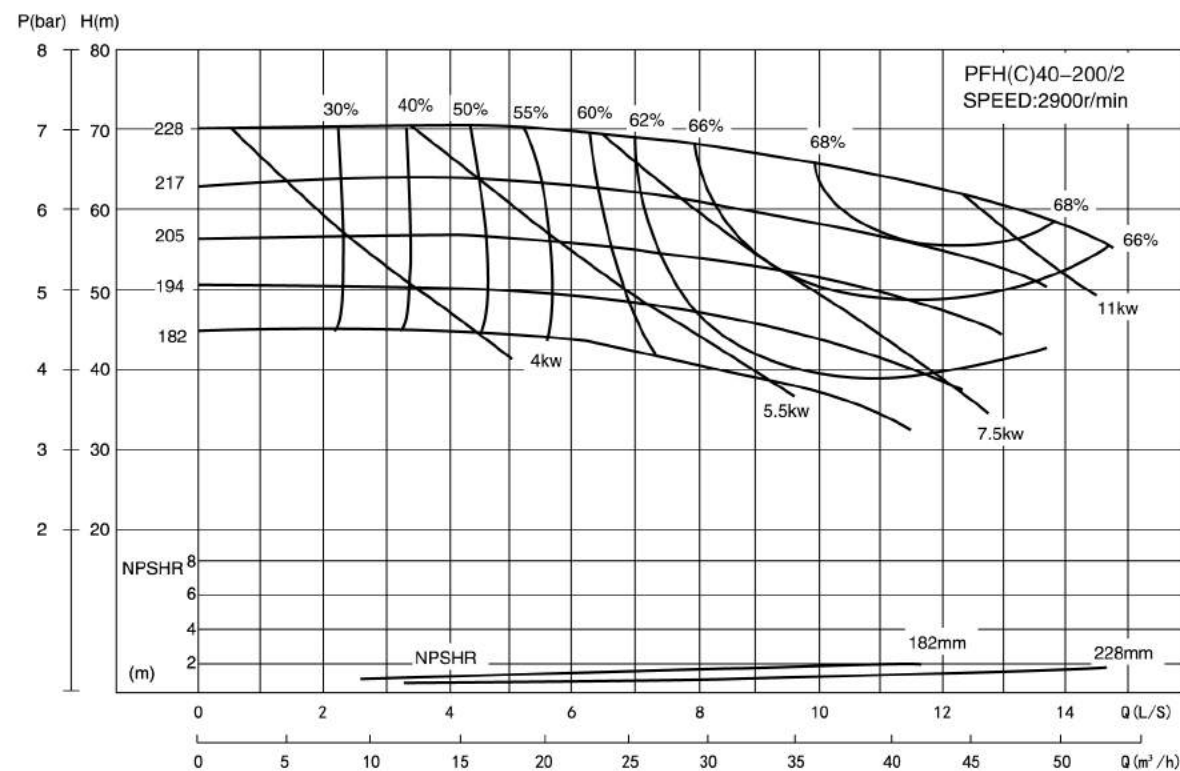

HORIZONTAL END SUCTION PUMP

PFH/PFHC SERIES / 卧式端吸泵
PFH/PFHC系列

I、PERFORMANCE CURVE CHART 性能曲线图(2900rpm)

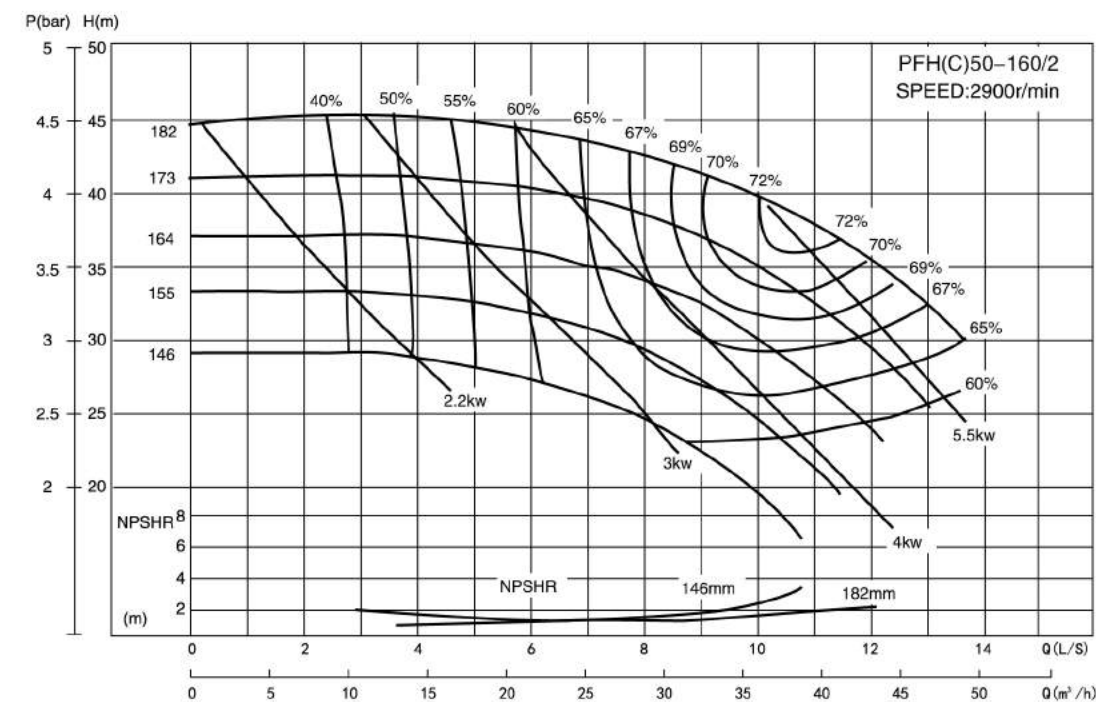
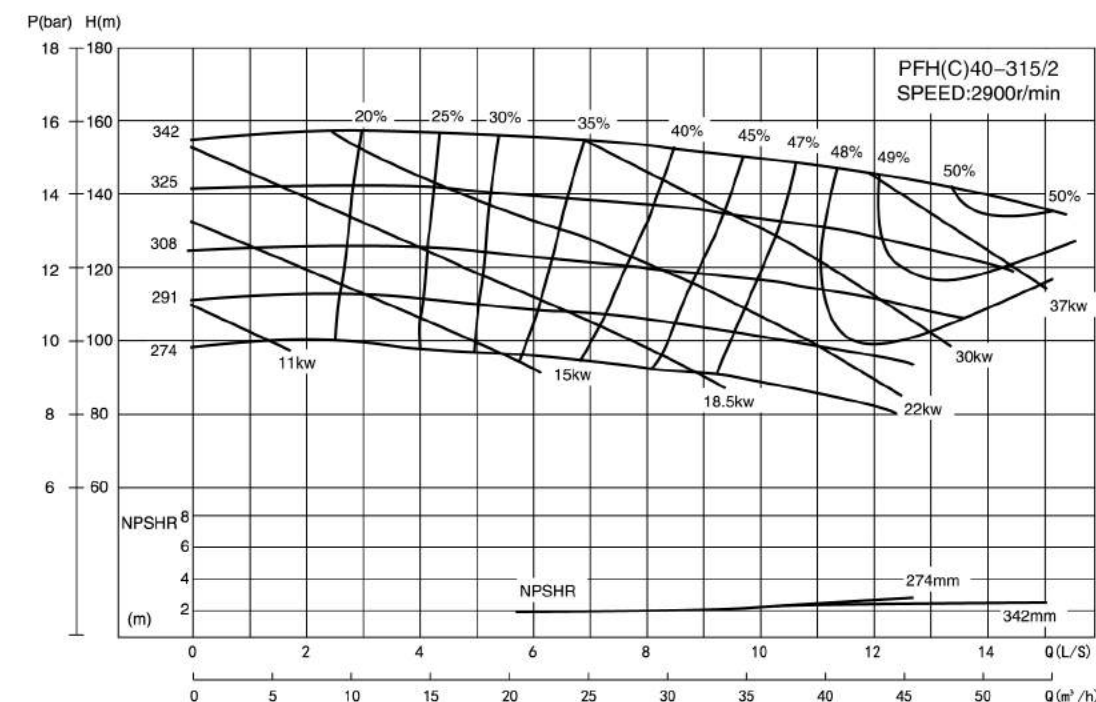

- PFH
- PFHC
- PFH/PFHC32
- PFH/PFHC40
- PFH/PFHC50
- PFH/PFHC65
- PFH/PFHC80
- PFH/PFHC100
- PFH/PFHC125
- PFH/PFHC150
- PFH/PFHC200
- PFH/PFHC250
- PFH/PFHC300
- OTHERS

HORIZONTAL END SUCTION PUMP

PFH/PFHC SERIES / 卧式端吸泵
PFH/PFHC系列

I、PERFORMANCE CURVE CHART 性能曲线图(2900rpm)

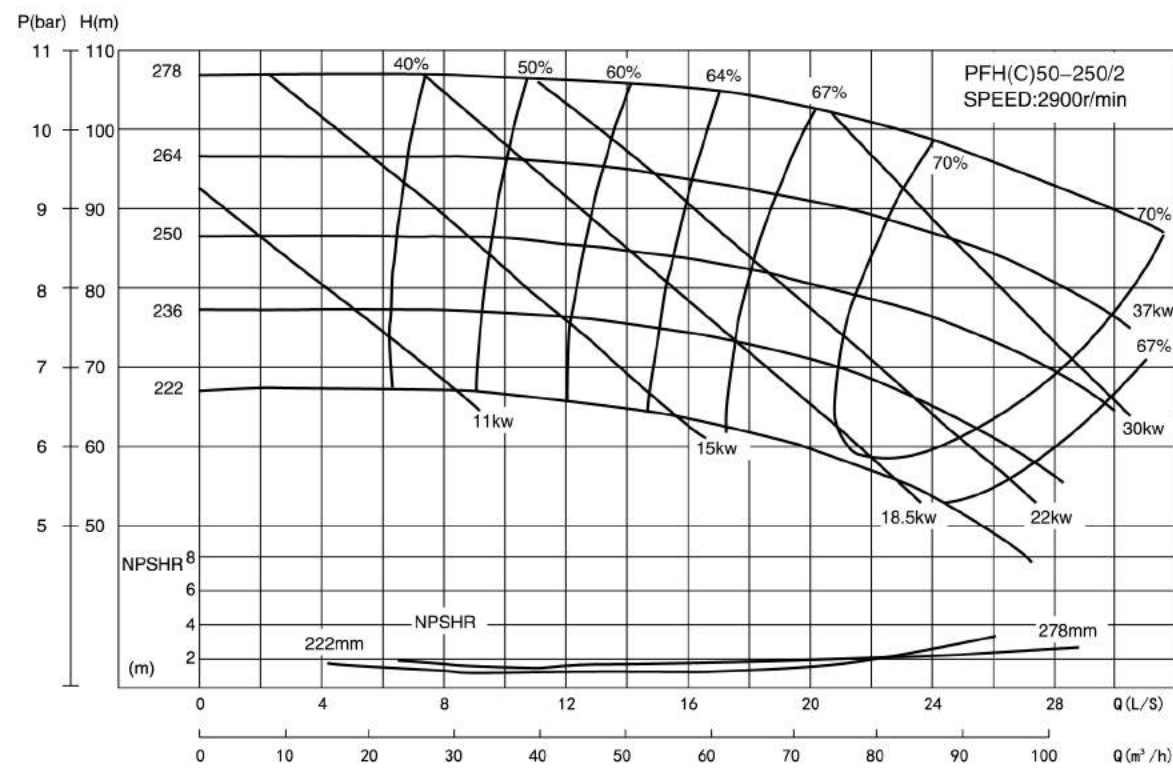
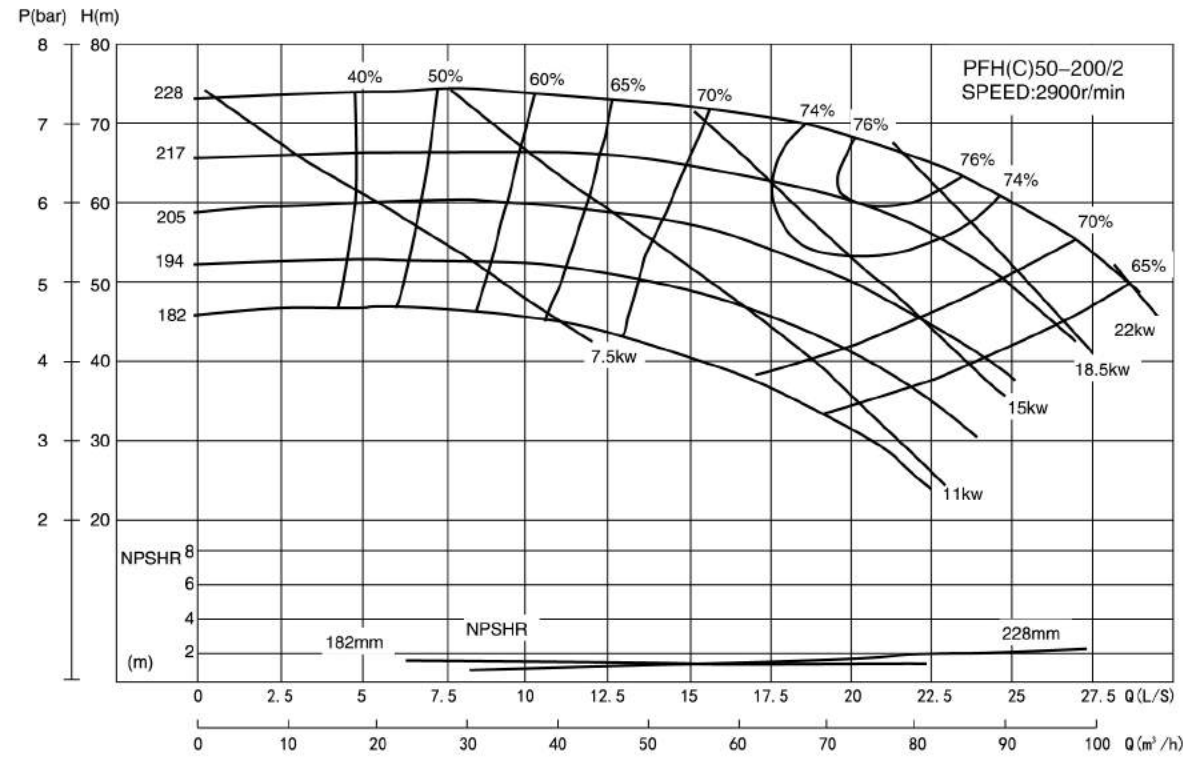

HORIZONTAL END SUCTION PUMP

PFH/PFHC SERIES / 卧式端吸泵
PFH/PFHC系列

I、PERFORMANCE CURVE CHART 性能曲线图(2900rpm)

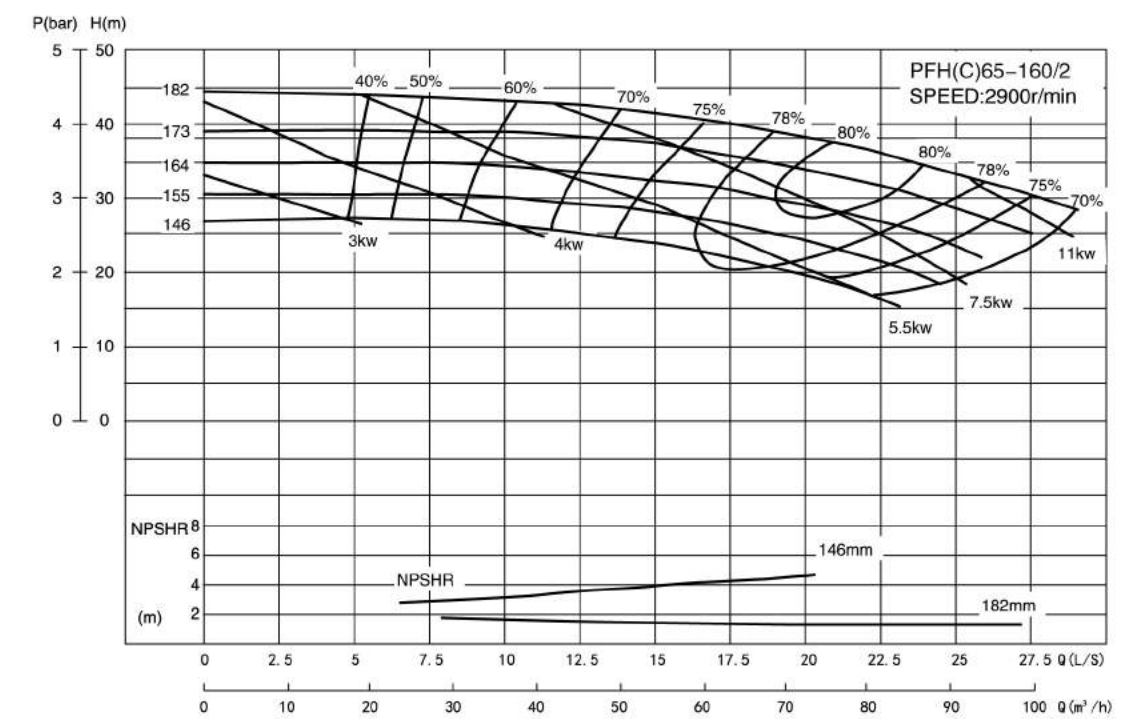
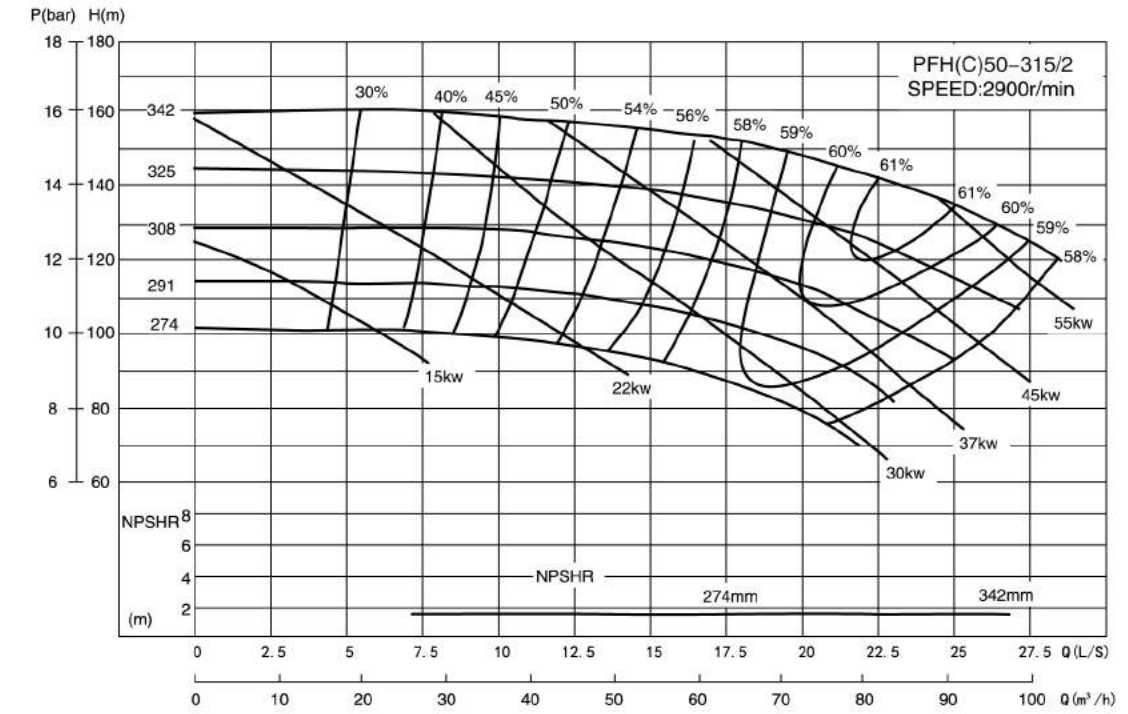

PFH

PFHC

PFH/PFHC32

PFH/PFHC40

PFH/PFHC50

PFH/PFHC65

PFH/PFHC80

PFH/PFHC100

PFH/PFHC125

PFH/PFHC150

PFH/PFHC200

PFH/PFHC250

PFH/PFHC300

OTHERS

HORIZONTAL END SUCTION PUMP

PFH/PFHC SERIES / 卧式端吸泵
PFH/PFHC系列

I、PERFORMANCE CURVE CHART 性能曲线图(2900rpm)

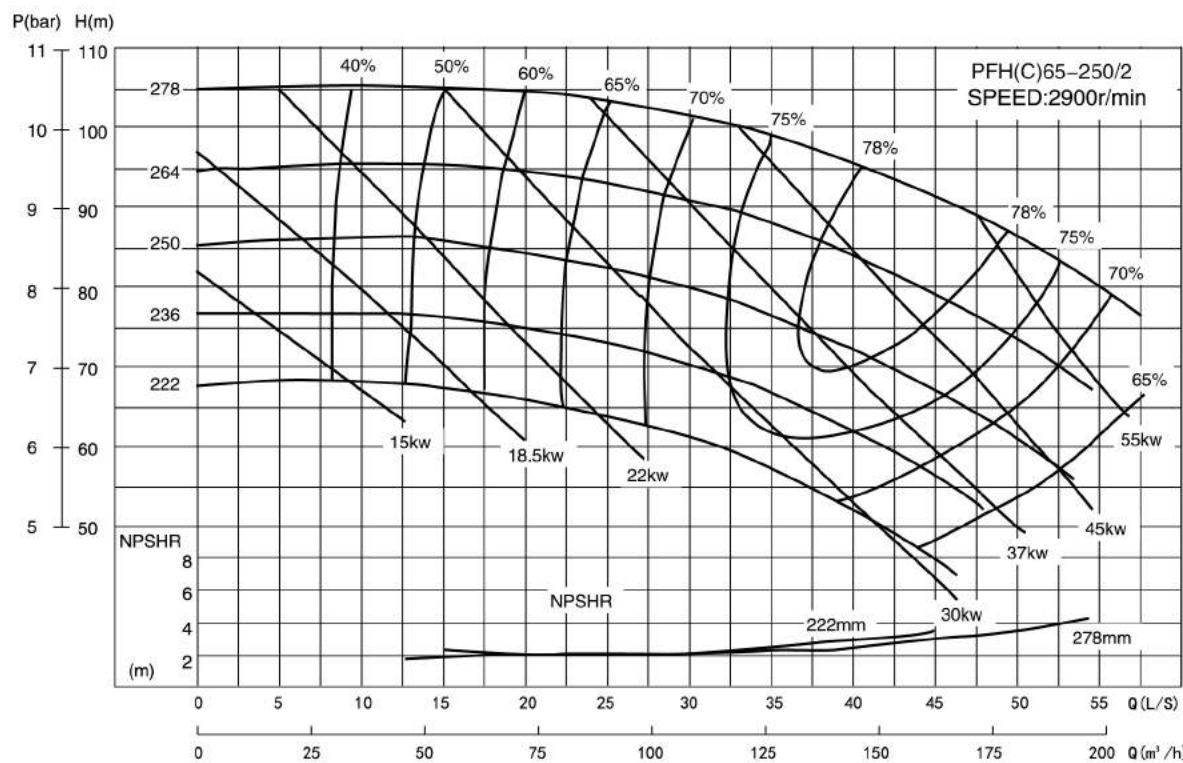
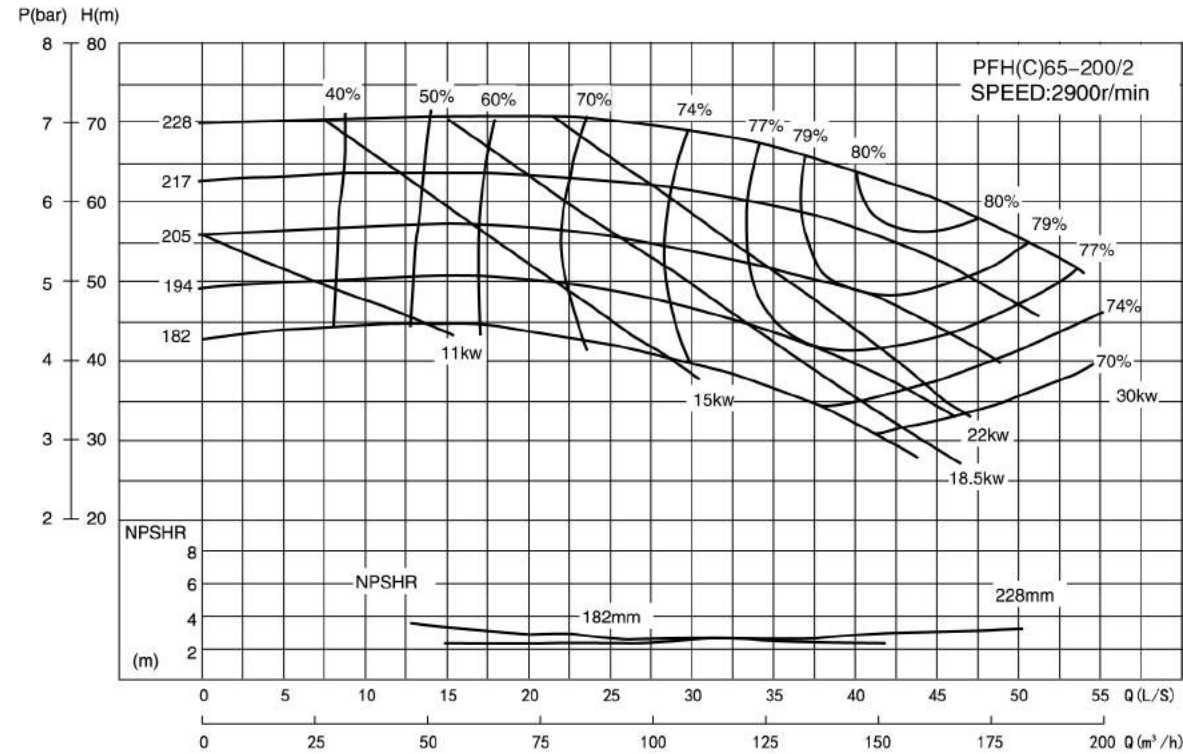

HORIZONTAL END SUCTION PUMP

PFH/PFHC SERIES / 卧式端吸泵
PFH/PFHC系列

I、PERFORMANCE CURVE CHART 性能曲线图(2900rpm)

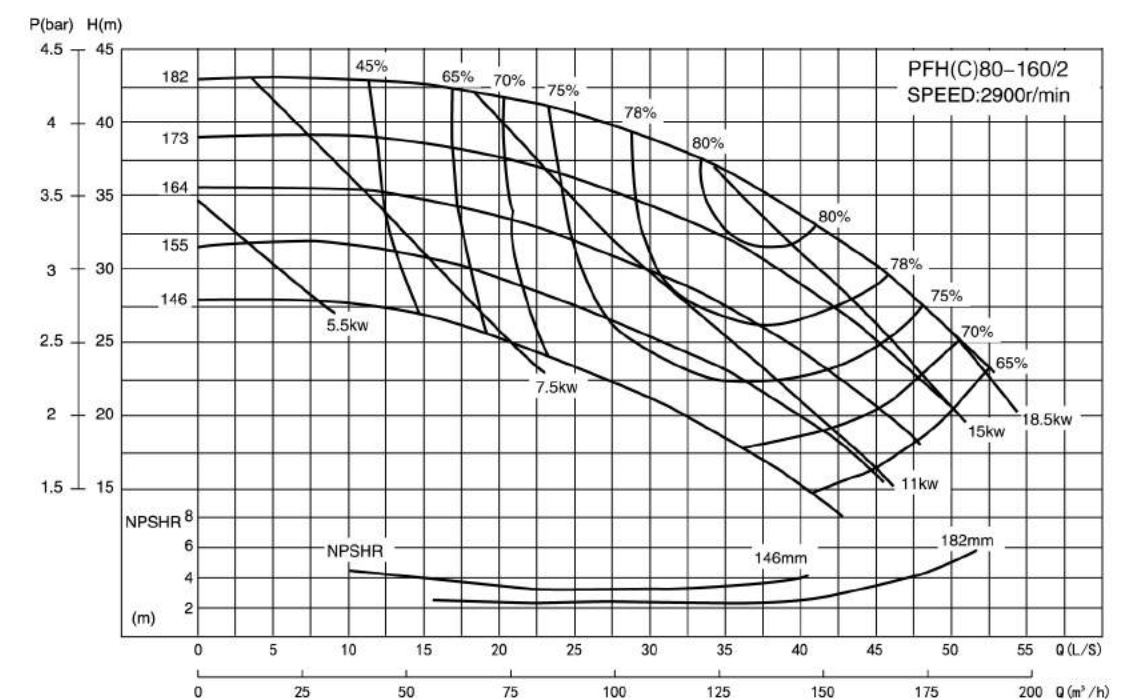
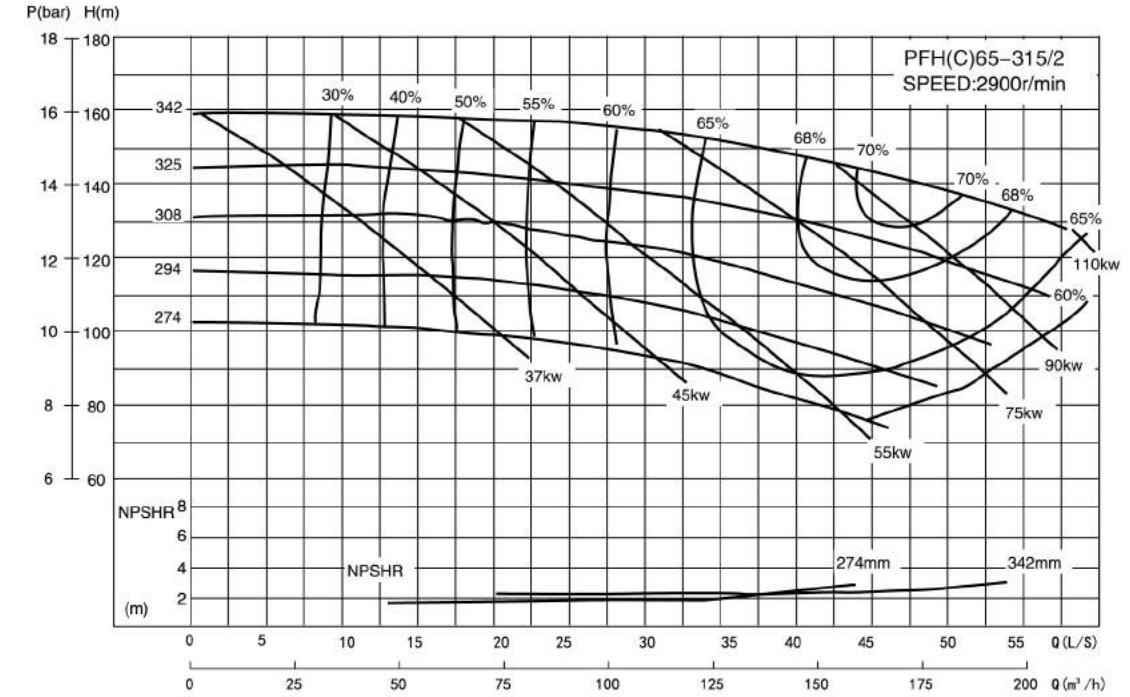

PFH

PFHC

PFH/PFHC32

PFH/PFHC40

PFH/PFHC50

PFH/PFHC65

PFH/PFHC80

PFH/PFHC100

PFH/PFHC125

PFH/PFHC150

PFH/PFHC200

PFH/PFHC250

PFH/PFHC300

OTHERS

HORIZONTAL END SUCTION PUMP

PFH/PFHC SERIES / 卧式端吸泵
PFH/PFHC系列

I、PERFORMANCE CURVE CHART 性能曲线图(2900rpm)

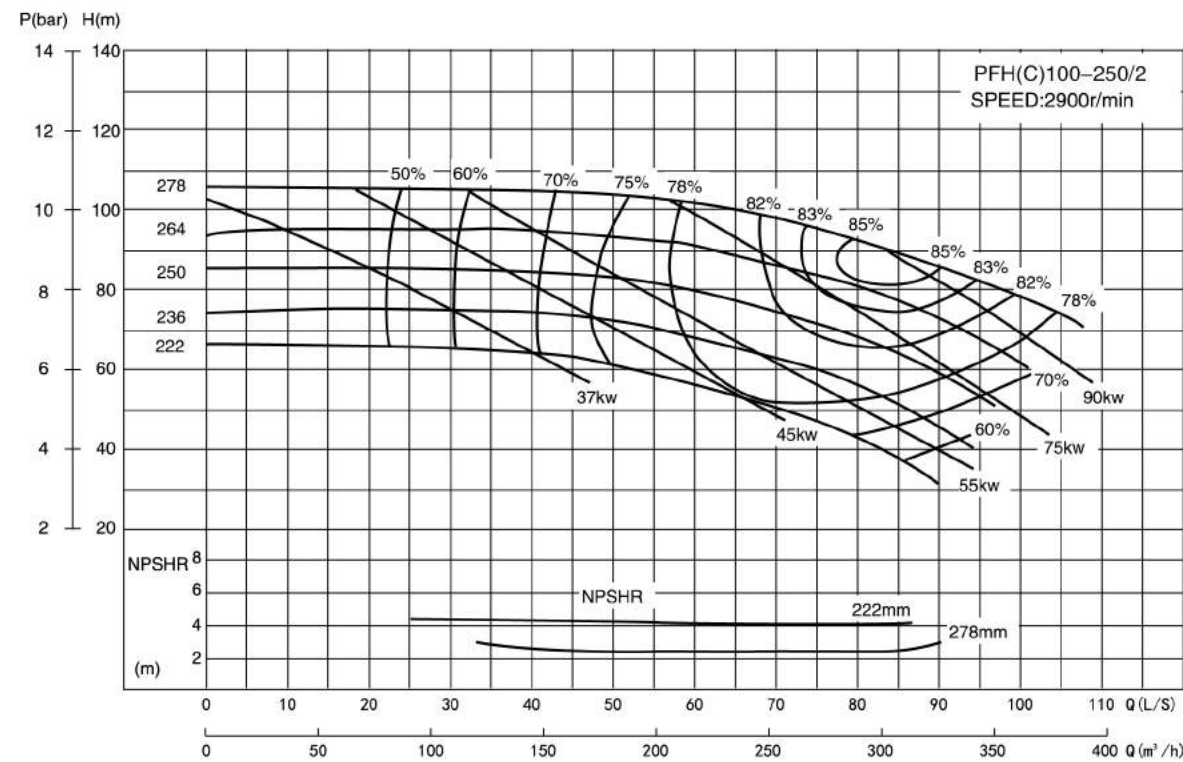
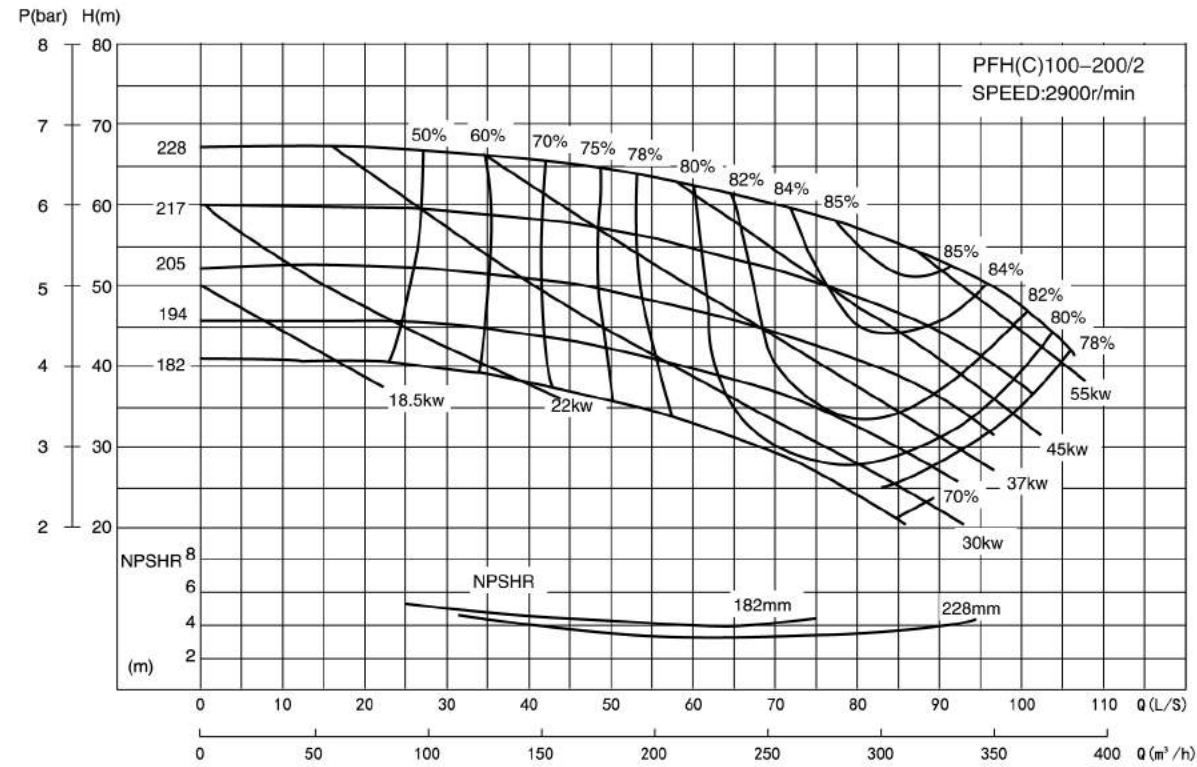

HORIZONTAL END SUCTION PUMP

PFH/PFHC SERIES / 卧式端吸泵
PFH/PFHC系列

I、PERFORMANCE CURVE CHART 性能曲线图(2900rpm)

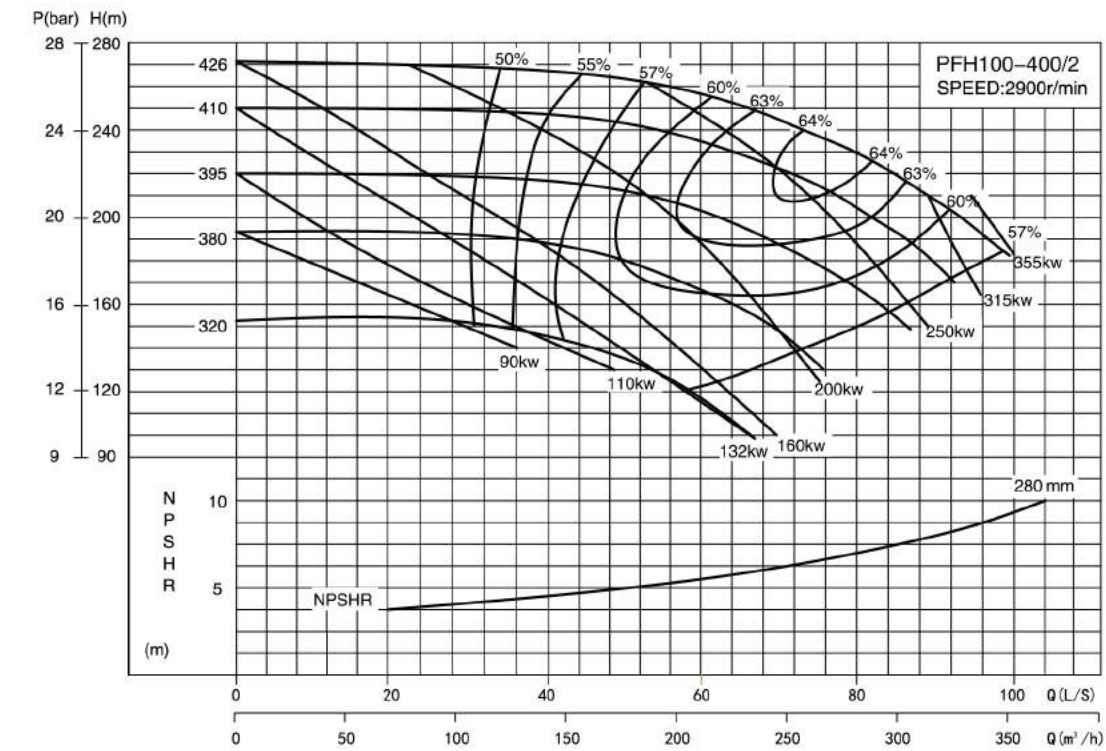
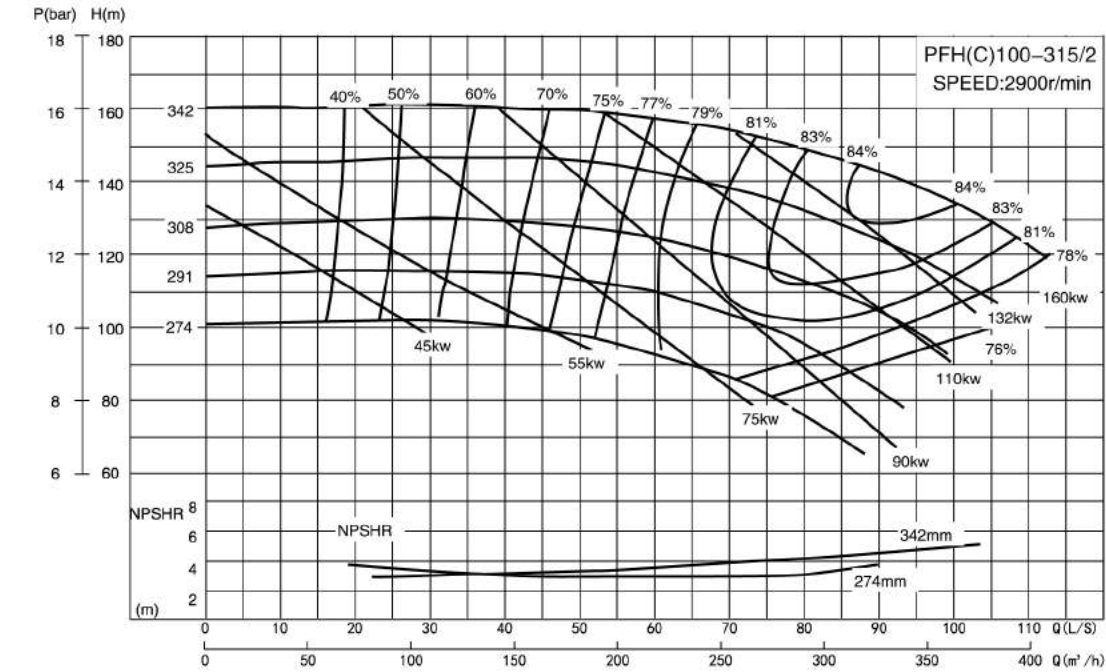

- PFH
- PFHC
- PFH/PFHC32
- PFH/PFHC40
- PFH/PFHC50
- PFH/PFHC65
- PFH/PFHC80
- PFH/PFHC100
- PFH/PFHC125
- PFH/PFHC150
- PFH/PFHC200
- PFH/PFHC250
- PFH/PFHC300
- OTHERS

HORIZONTAL END SUCTION PUMP

PFH/PFHC SERIES / 卧式端吸泵
PFH/PFHC系列

I、PERFORMANCE CURVE CHART 性能曲线图(2900rpm)

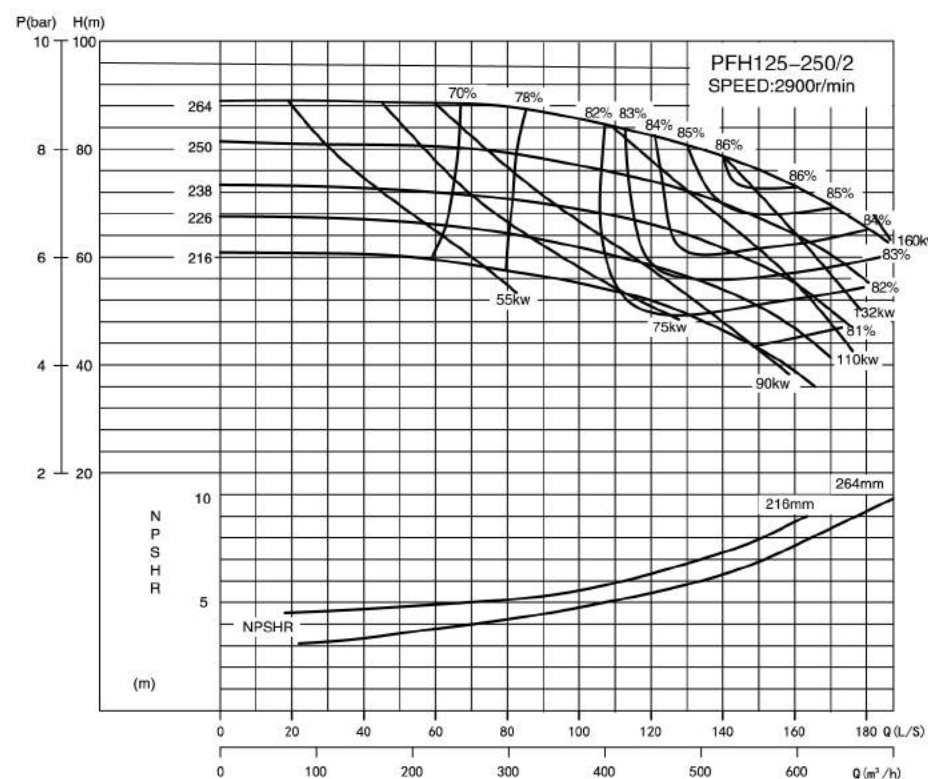
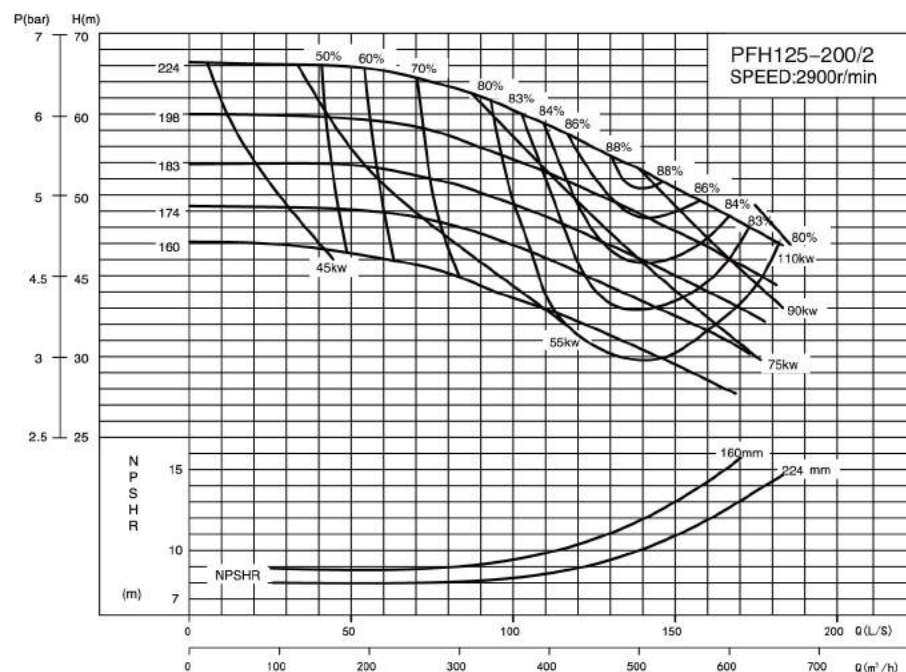

HORIZONTAL END SUCTION PUMP

PFH/PFHC SERIES / 卧式端吸泵
PFH/PFHC系列

I、PERFORMANCE CURVE CHART 性能曲线图(2900rpm)

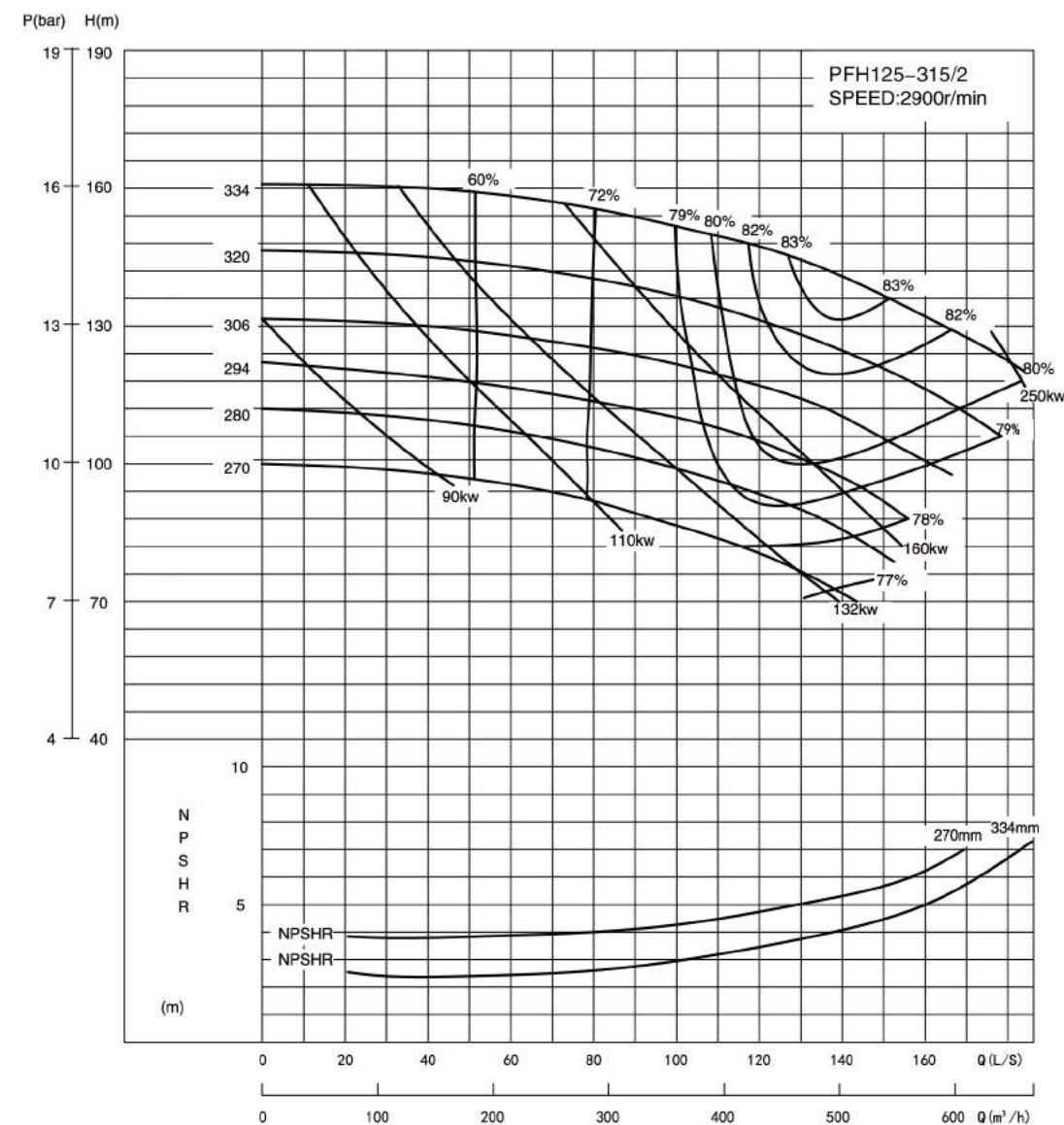

- PFH
- PFHC
- PFH/PFHC32
- PFH/PFHC40
- PFH/PFHC50
- PFH/PFHC65
- PFH/PFHC80
- PFH/PFHC100
- PFH/PFHC125
- PFH/PFHC150
- PFH/PFHC200
- PFH/PFHC250
- PFH/PFHC300
- OTHERS

HORIZONTAL END SUCTION PUMP

PFH/PFHC SERIES / 卧式端吸泵
PFH/PFHC系列

I、PERFORMANCE CURVE CHART 性能曲线图(1450rpm)

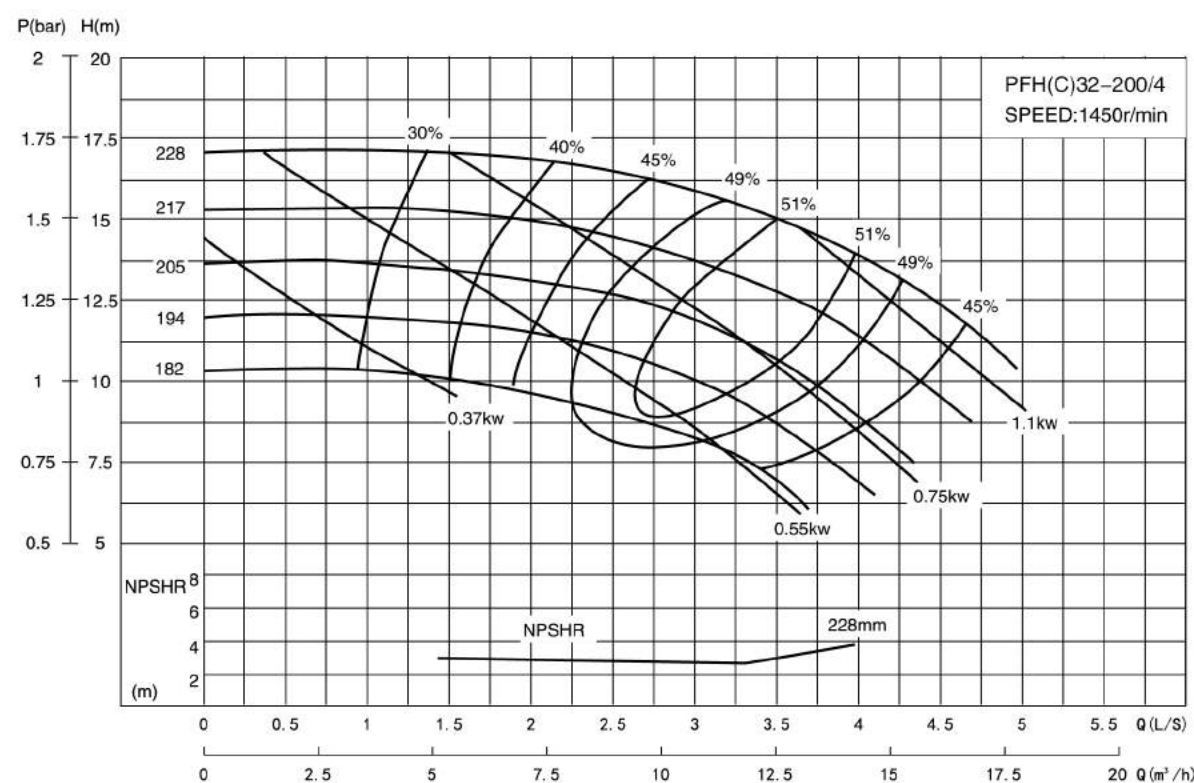
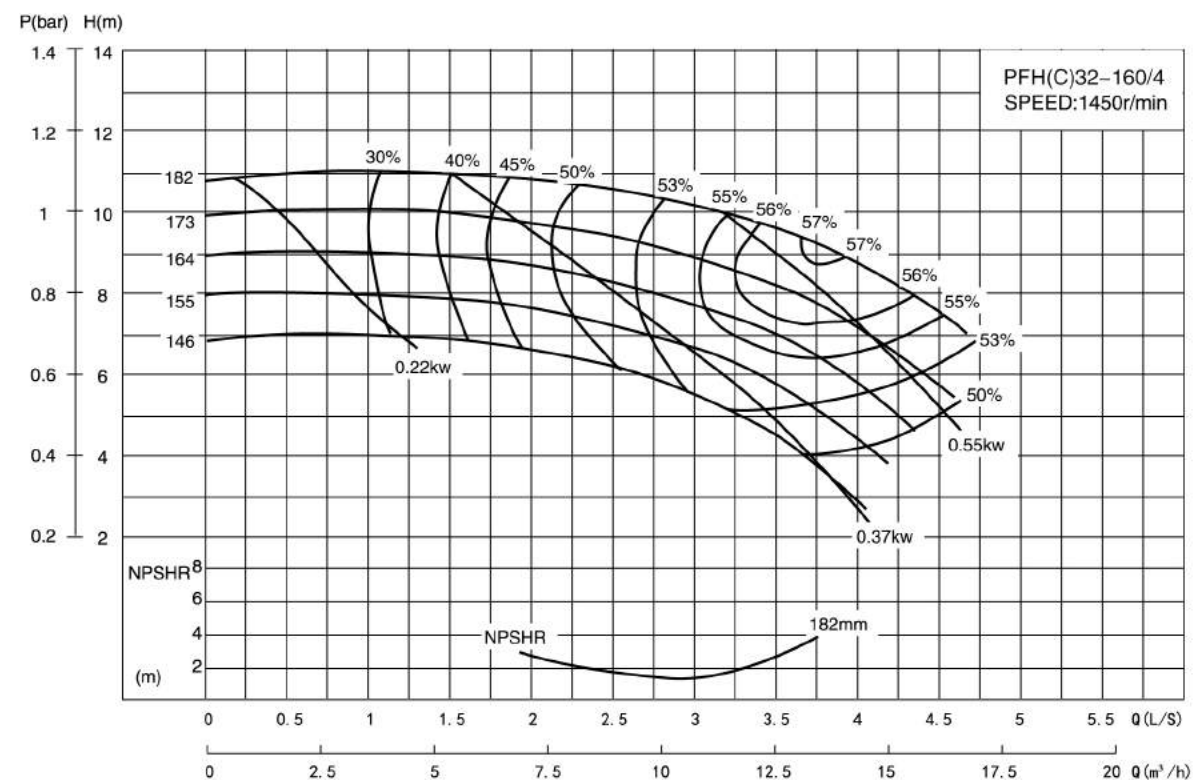

HORIZONTAL END SUCTION PUMP

PFH/PFHC SERIES / 卧式端吸泵
PFH/PFHC系列

2、PERFORMANCE CURVE CHART 性能曲线图(1450rpm)

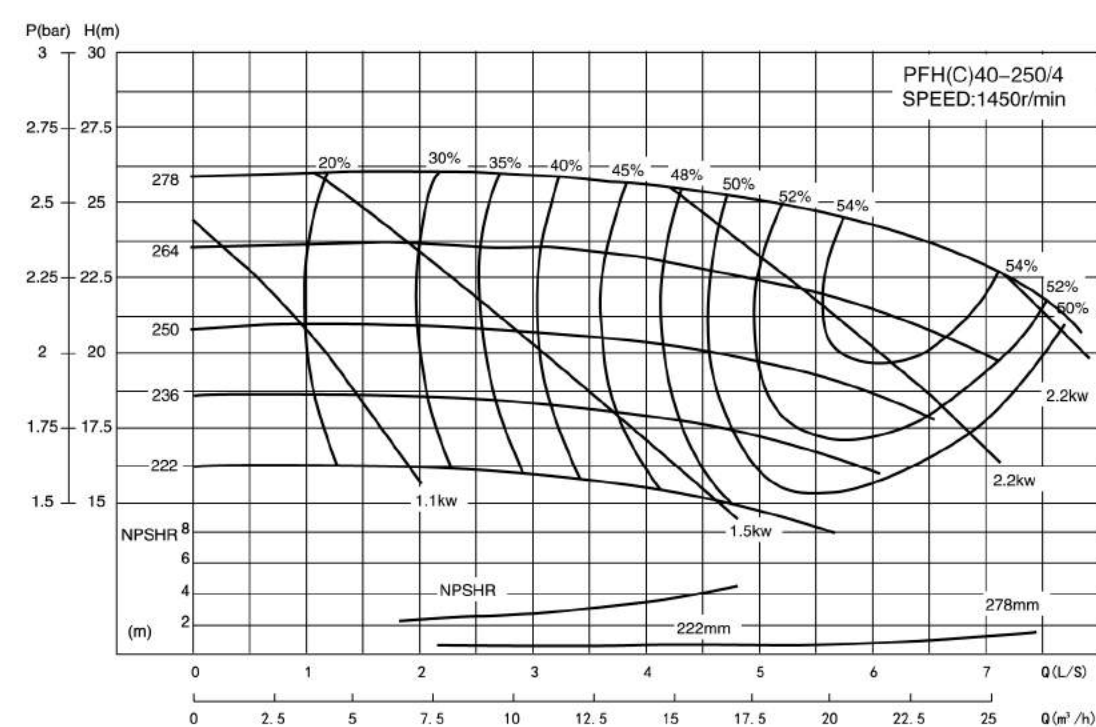
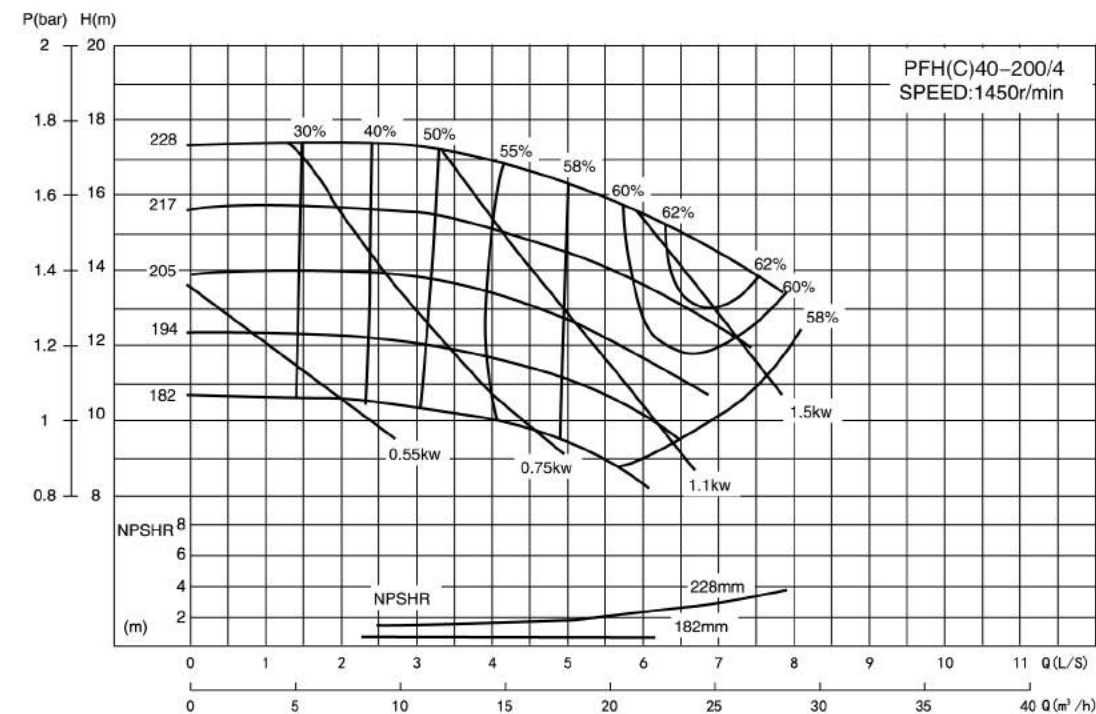

- PFH
- PFHC
- PFH/PFHC32
- PFH/PFHC40
- PFH/PFHC50
- PFH/PFHC65
- PFH/PFHC80
- PFH/PFHC100
- PFH/PFHC125
- PFH/PFHC150
- PFH/PFHC200
- PFH/PFHC250
- PFH/PFHC300
- OTHERS

HORIZONTAL END SUCTION PUMP

PFH/PFHC SERIES / 卧式端吸泵
PFH/PFHC系列

3、PERFORMANCE CURVE CHART 性能曲线图(1450rpm)

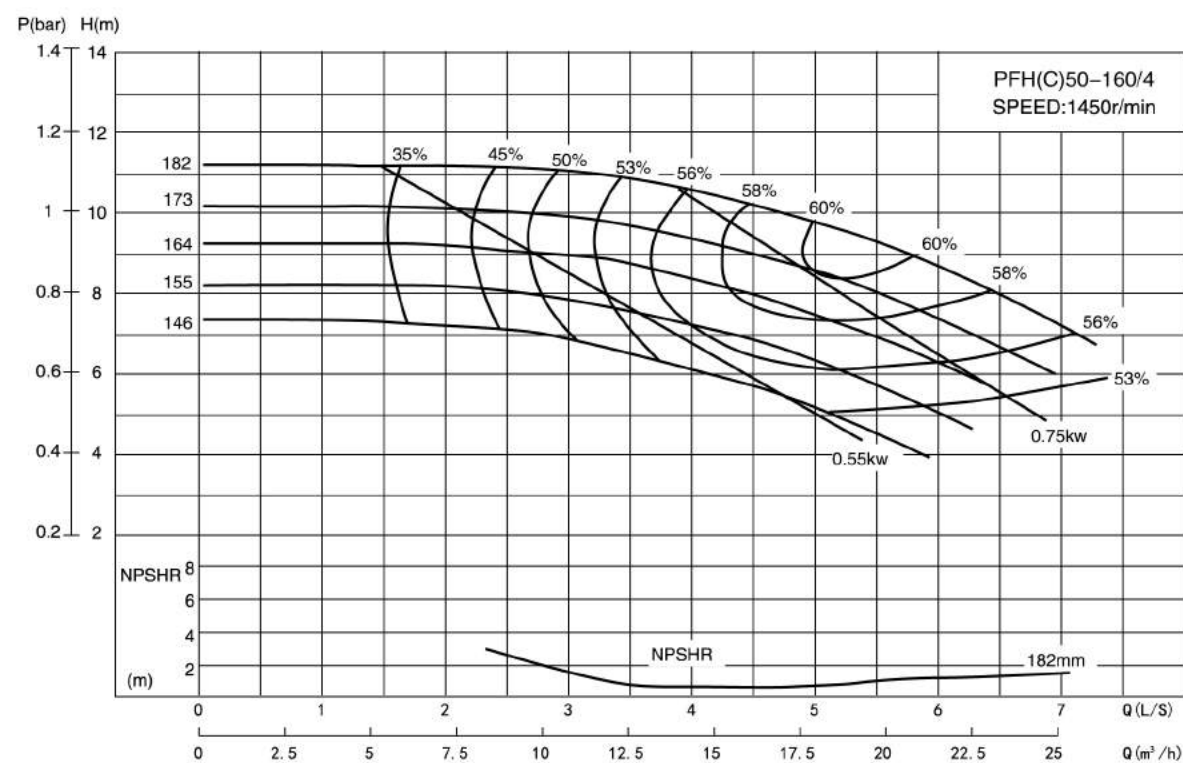
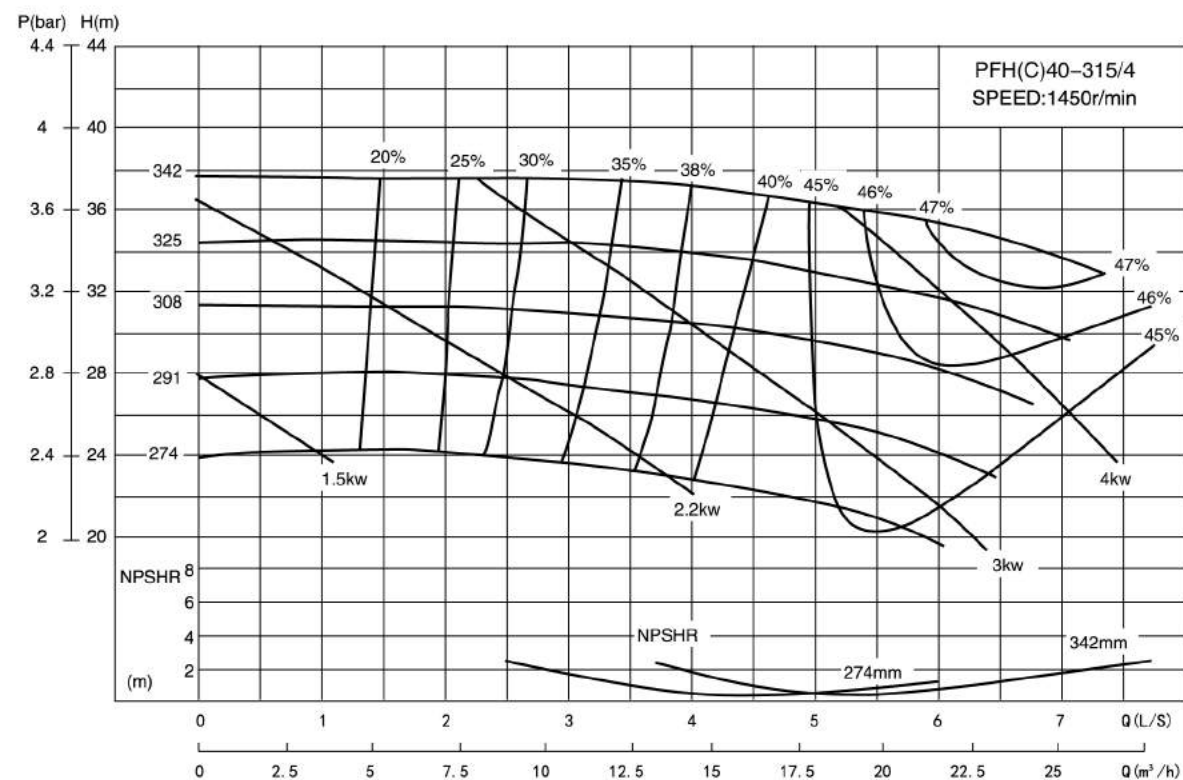

HORIZONTAL END SUCTION PUMP

PFH/PFHC SERIES / 卧式端吸泵
PFH/PFHC系列

4、PERFORMANCE CURVE CHART 性能曲线图(1450rpm)

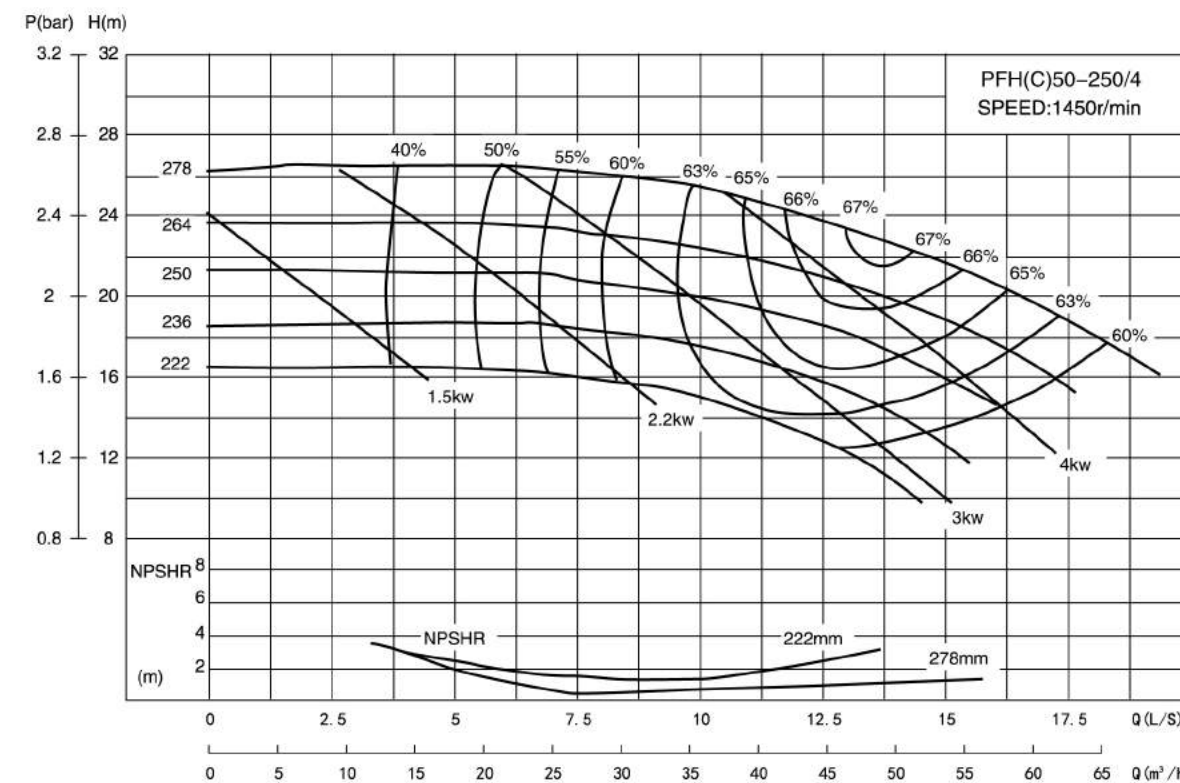
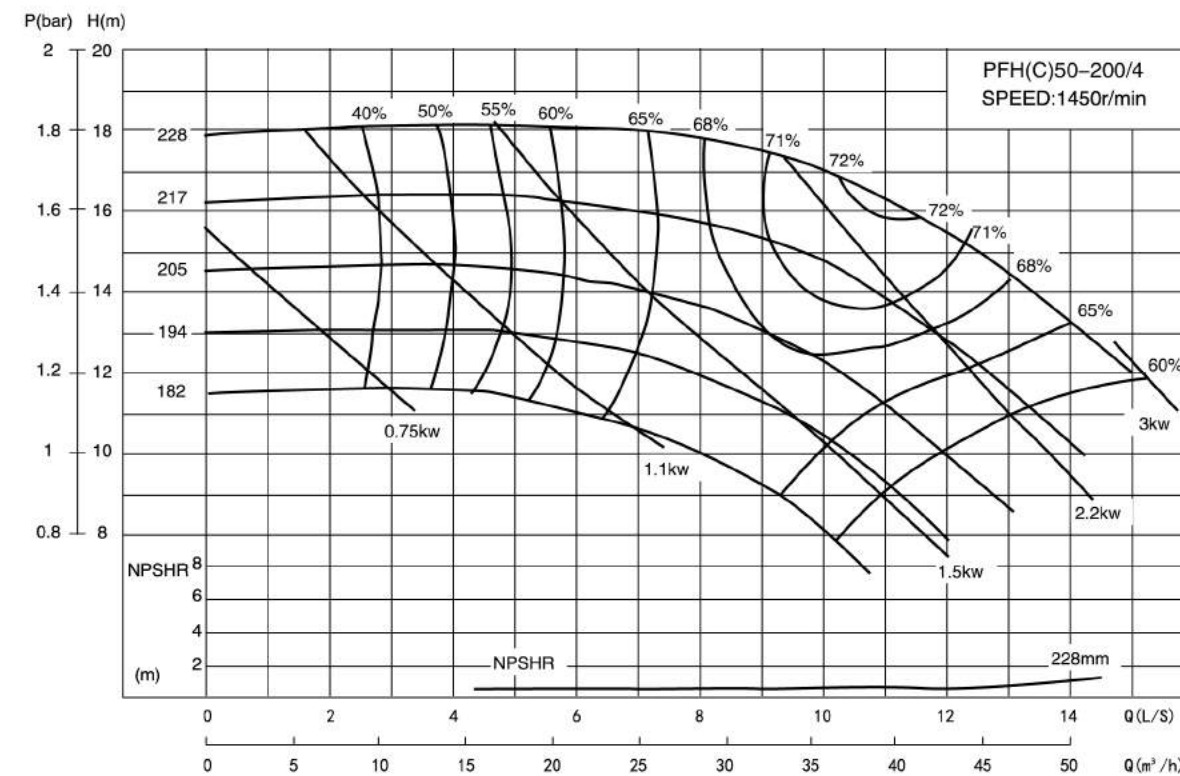

- PFH
- PFHC
- PFH/PFHC32
- PFH/PFHC40
- PFH/PFHC50
- PFH/PFHC65
- PFH/PFHC80
- PFH/PFHC100
- PFH/PFHC125
- PFH/PFHC150
- PFH/PFHC200
- PFH/PFHC250
- PFH/PFHC300
- OTHERS

HORIZONTAL END SUCTION PUMP

PFH/PFHC SERIES / 卧式端吸泵
PFH/PFHC系列

5、PERFORMANCE CURVE CHART 性能曲线图(1450rpm)

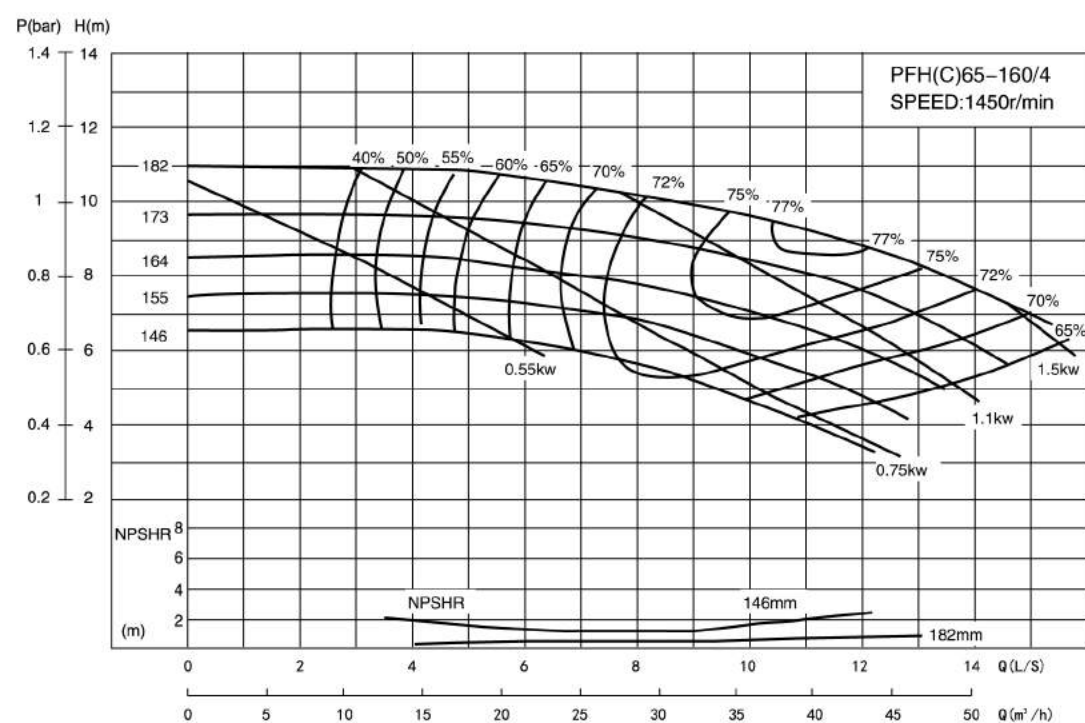
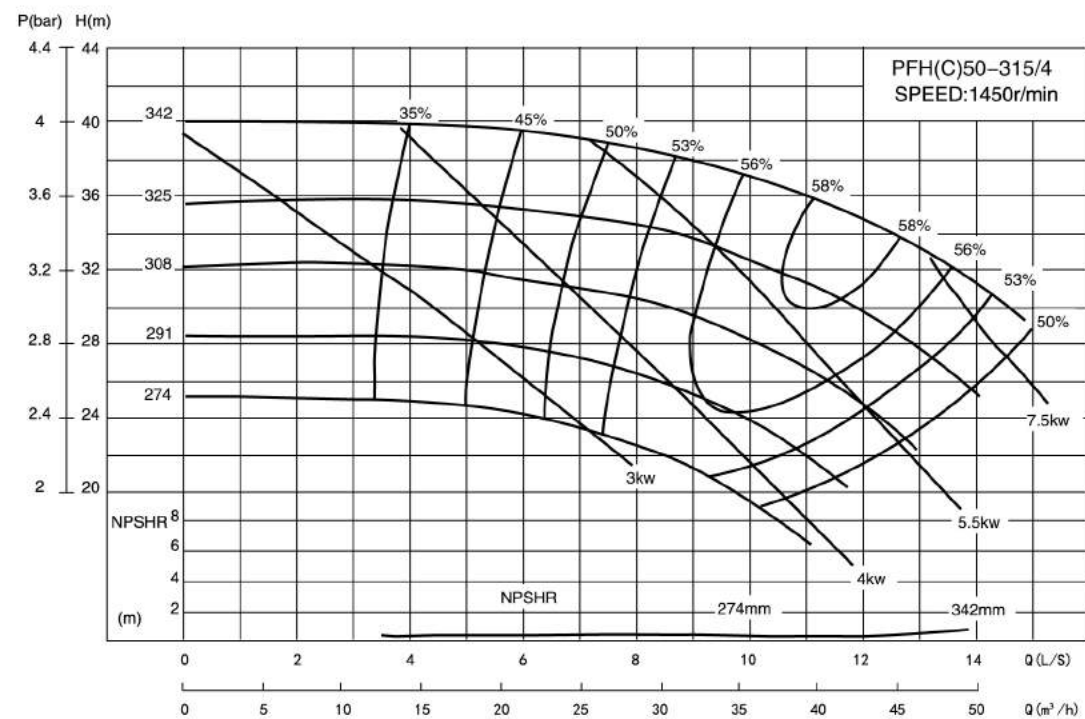

HORIZONTAL END SUCTION PUMP

PFH/PFHC SERIES / 卧式端吸泵
PFH/PFHC系列

6、PERFORMANCE CURVE CHART 性能曲线图(1450rpm)

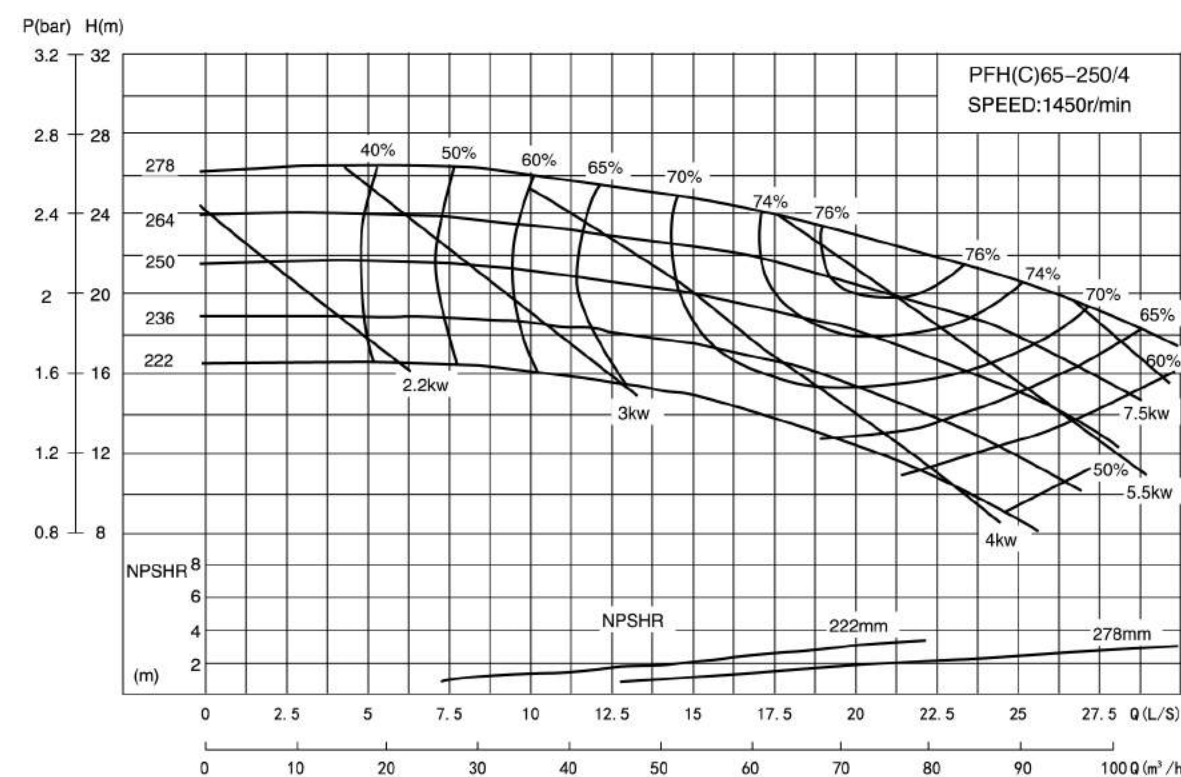
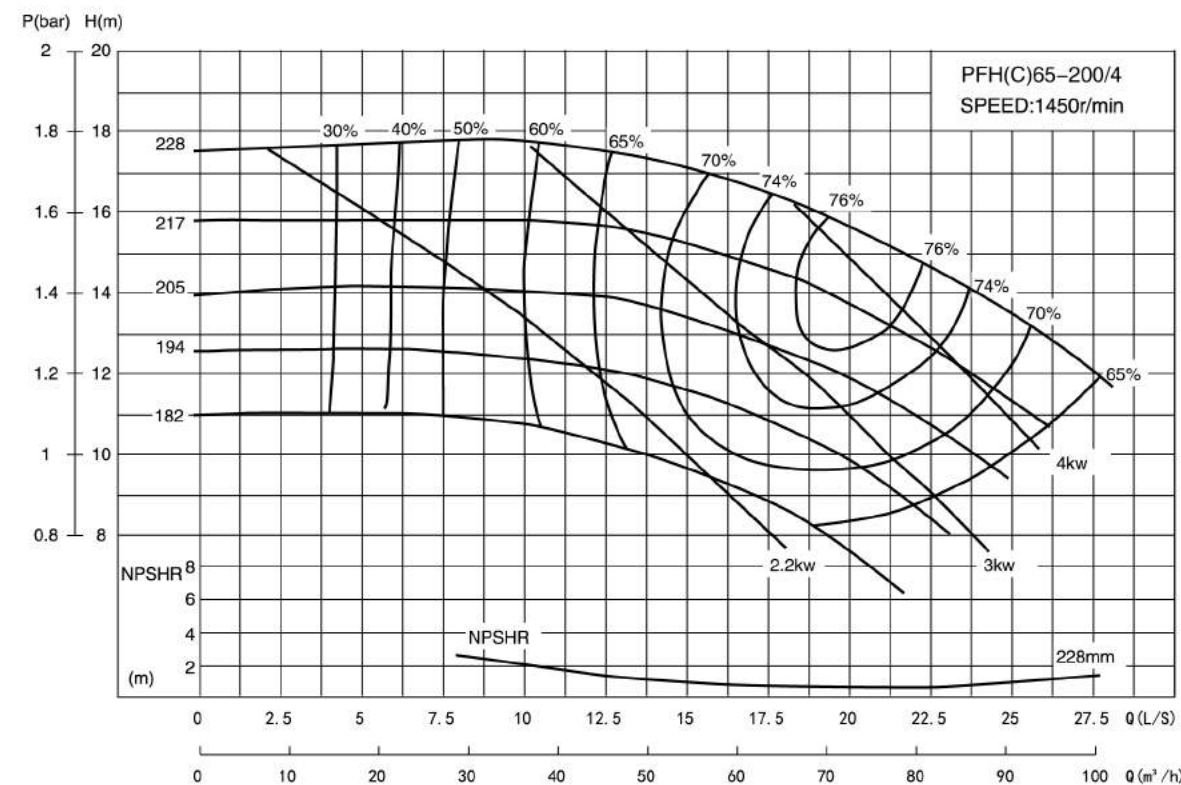

- PFH
- PFHC
- PFH/PFHC32
- PFH/PFHC40
- PFH/PFHC50
- PFH/PFHC65
- PFH/PFHC80
- PFH/PFHC100
- PFH/PFHC125
- PFH/PFHC150
- PFH/PFHC200
- PFH/PFHC250
- PFH/PFHC300
- OTHERS

HORIZONTAL END SUCTION PUMP

PFH/PFHC SERIES / 卧式端吸泵
PFH/PFHC系列

I、PERFORMANCE CURVE CHART 性能曲线图(1450rpm)

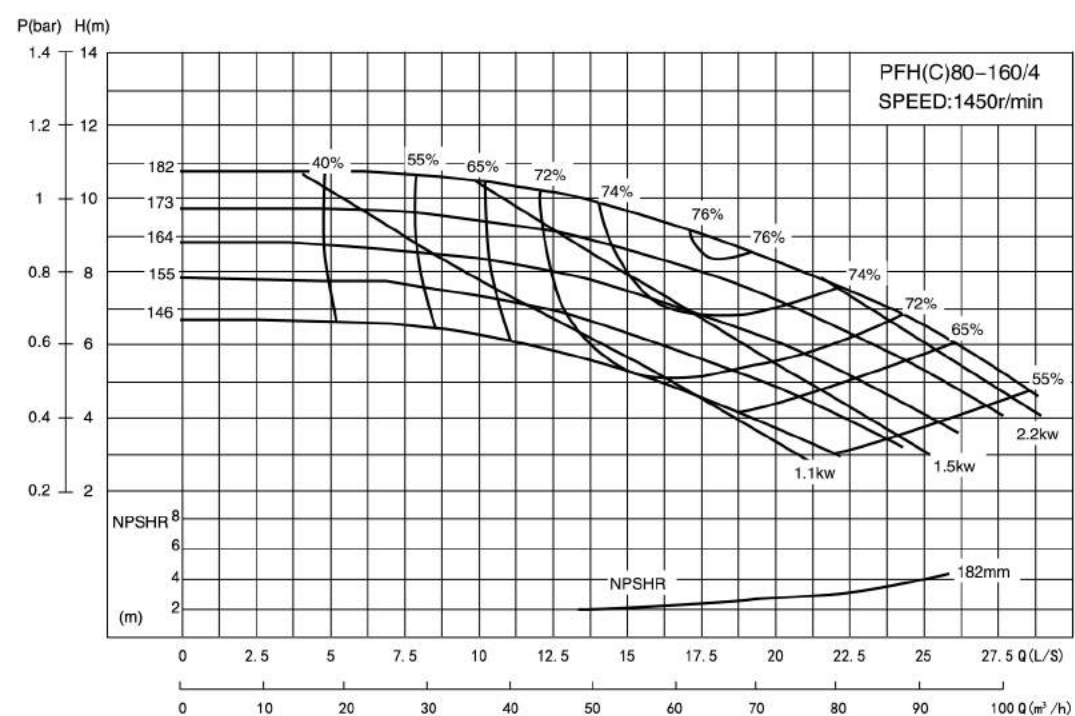
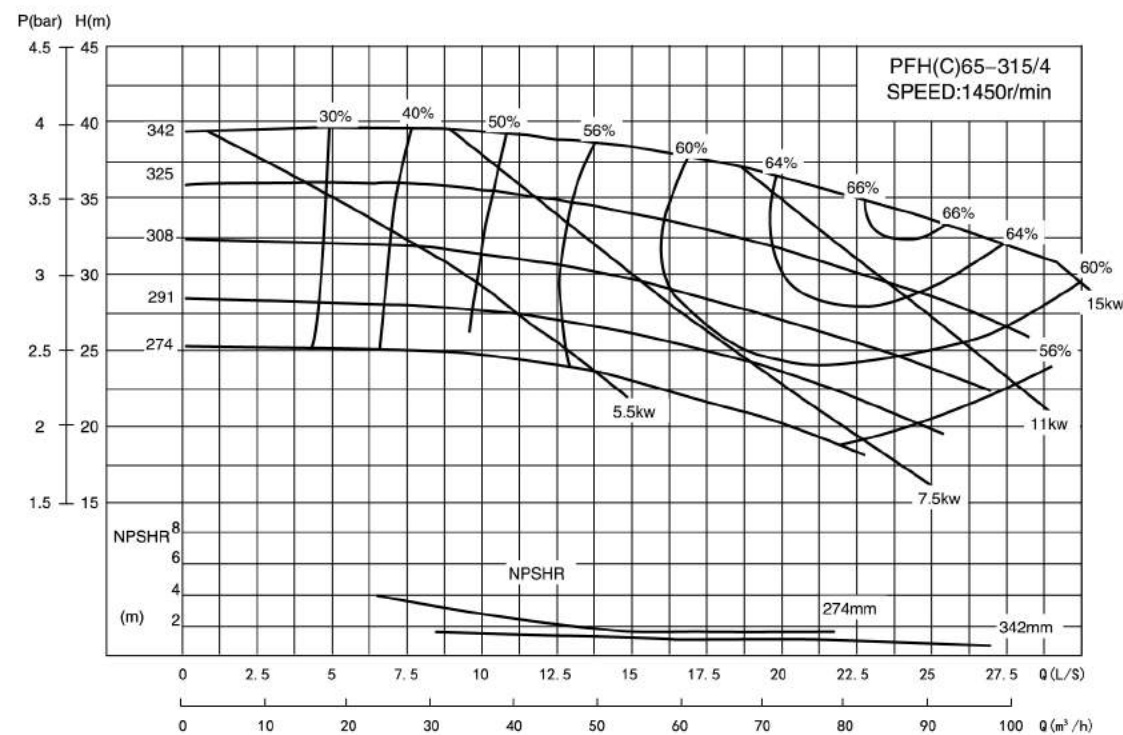

HORIZONTAL END SUCTION PUMP

PFH/PFHC SERIES / 卧式端吸泵
PFH/PFHC系列

I、PERFORMANCE CURVE CHART 性能曲线图(1450rpm)

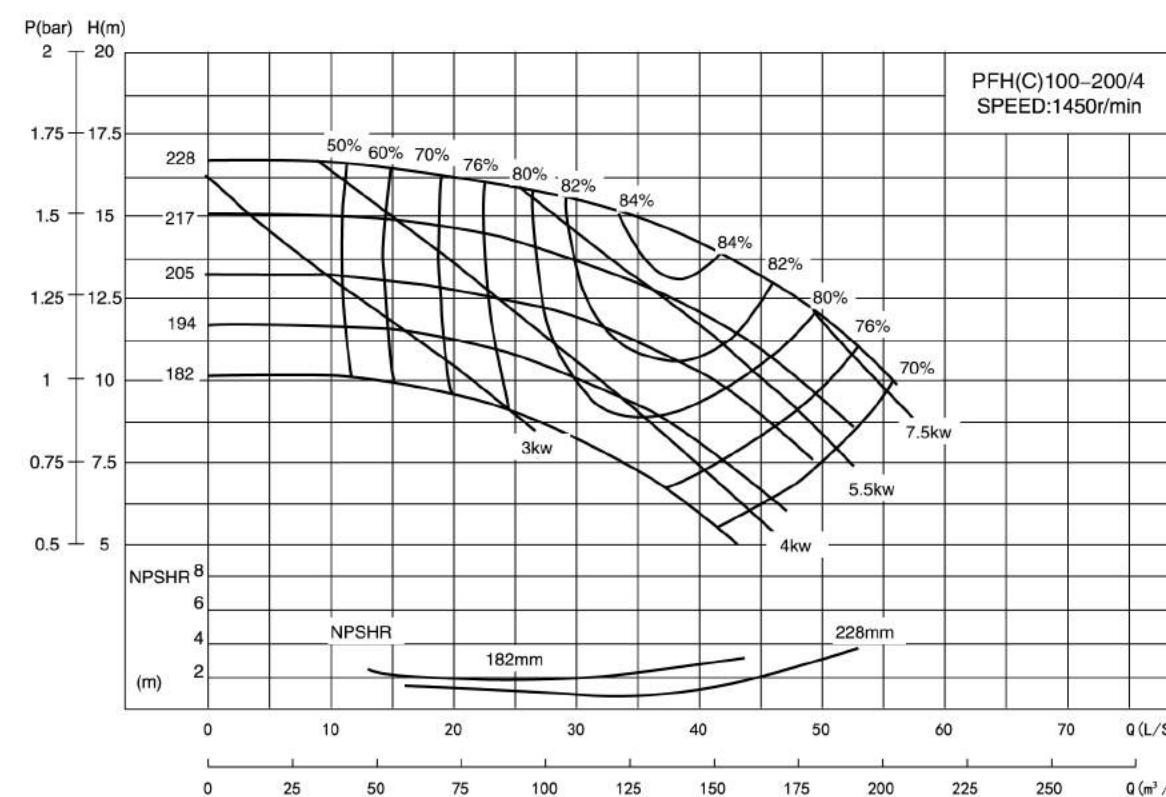
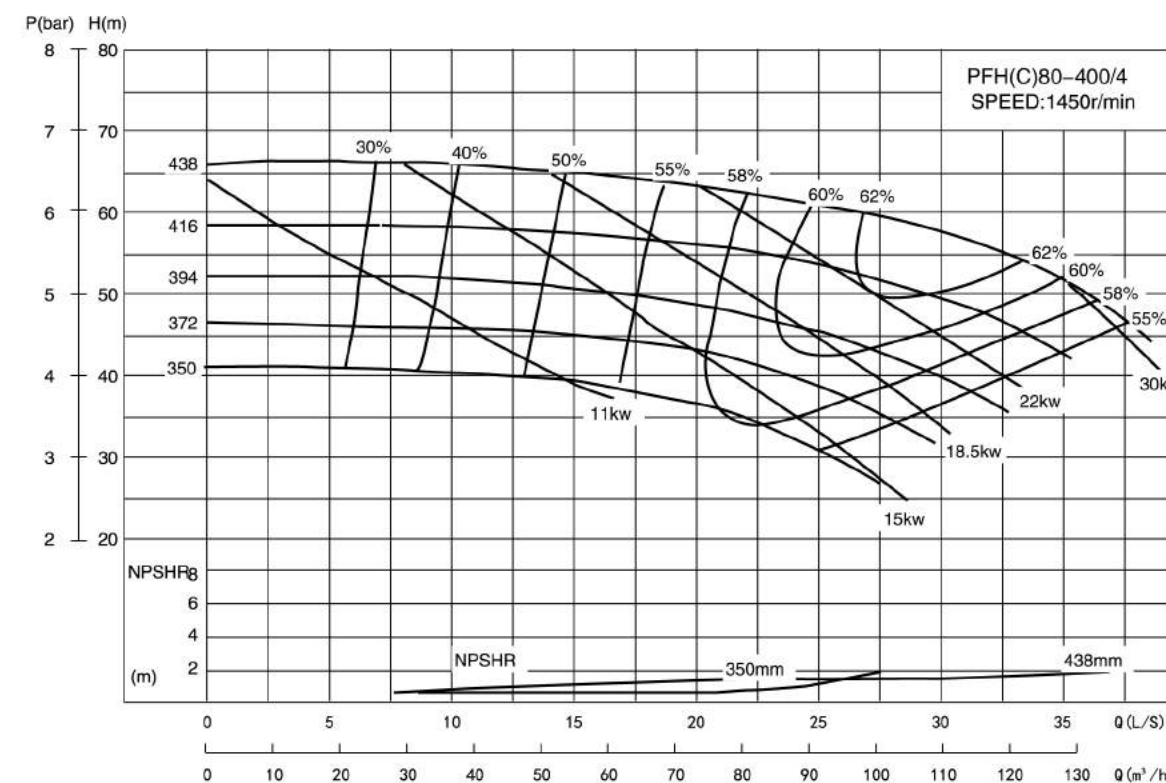

- PFH
- PFHC
- PFH/PFHC32
- PFH/PFHC40
- PFH/PFHC50
- PFH/PFHC65
- PFH/PFHC80
- PFH/PFHC100
- PFH/PFHC125
- PFH/PFHC150
- PFH/PFHC200
- PFH/PFHC250
- PFH/PFHC300
- OTHERS

HORIZONTAL END SUCTION PUMP

PFH/PFHC SERIES / 卧式端吸泵
PFH/PFHC系列

I、PERFORMANCE CURVE CHART 性能曲线图(1450rpm)

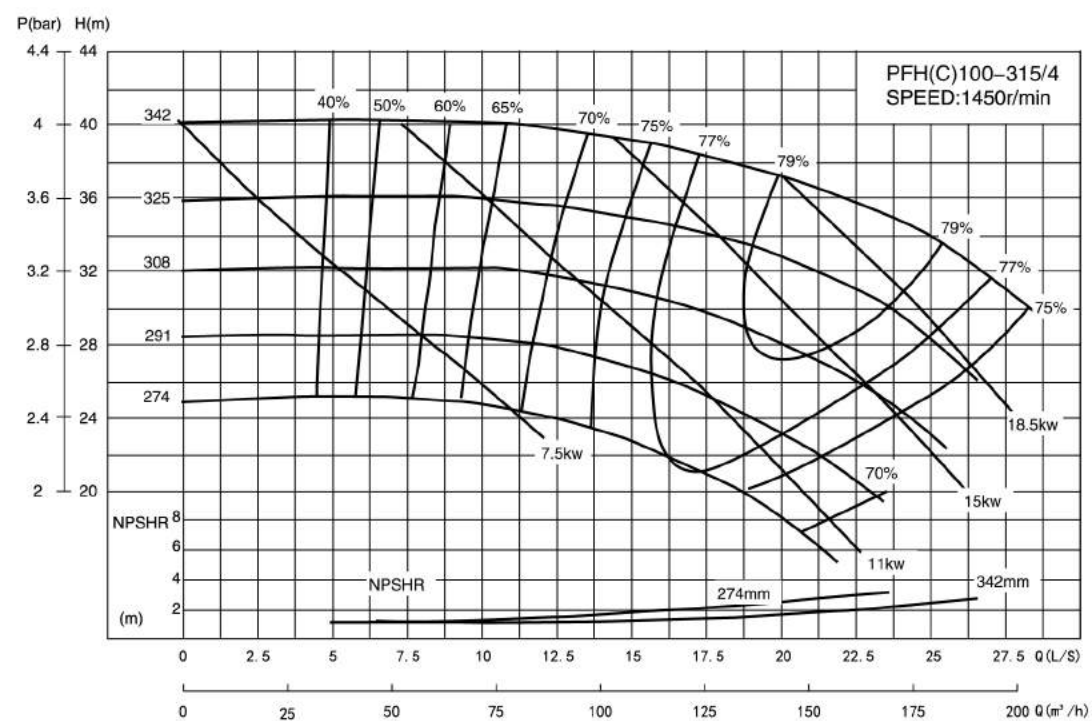
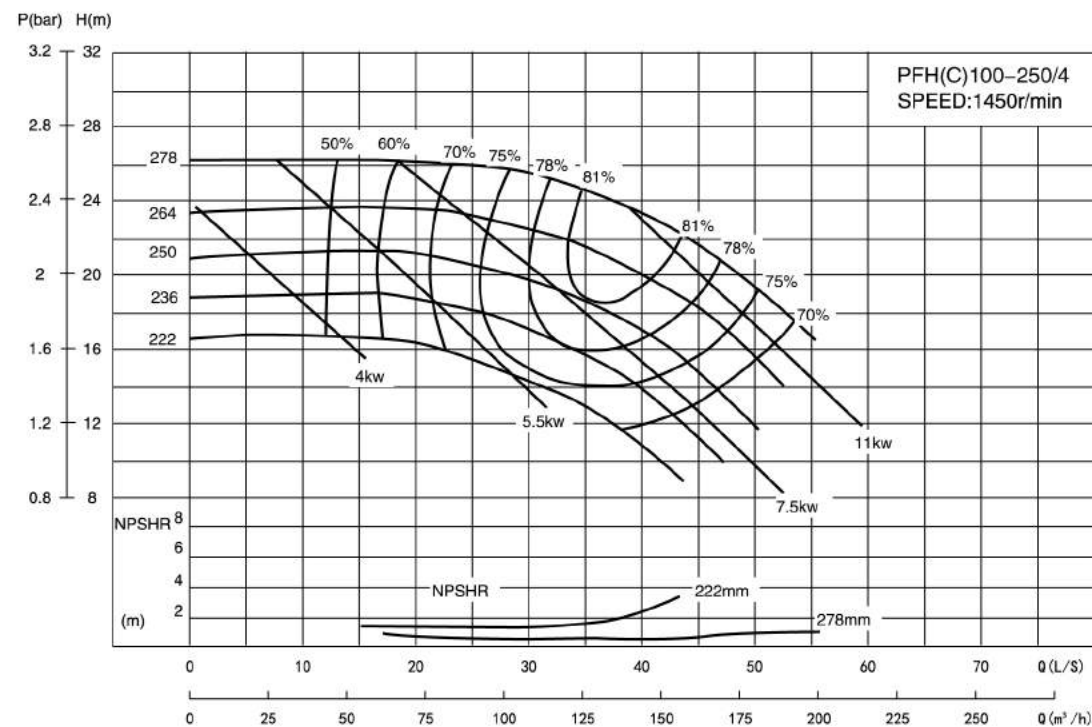

HORIZONTAL END SUCTION PUMP

PFH/PFHC SERIES / 卧式端吸泵
PFH/PFHC系列

I、PERFORMANCE CURVE CHART 性能曲线图(1450rpm)

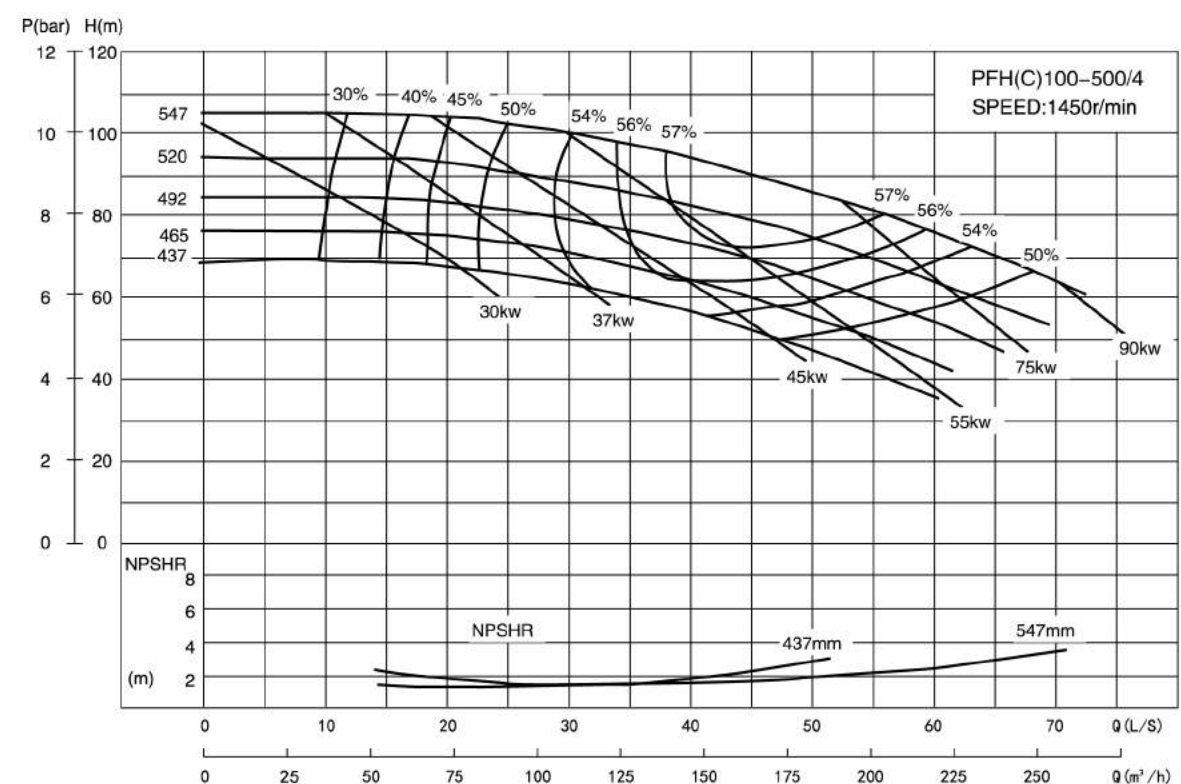
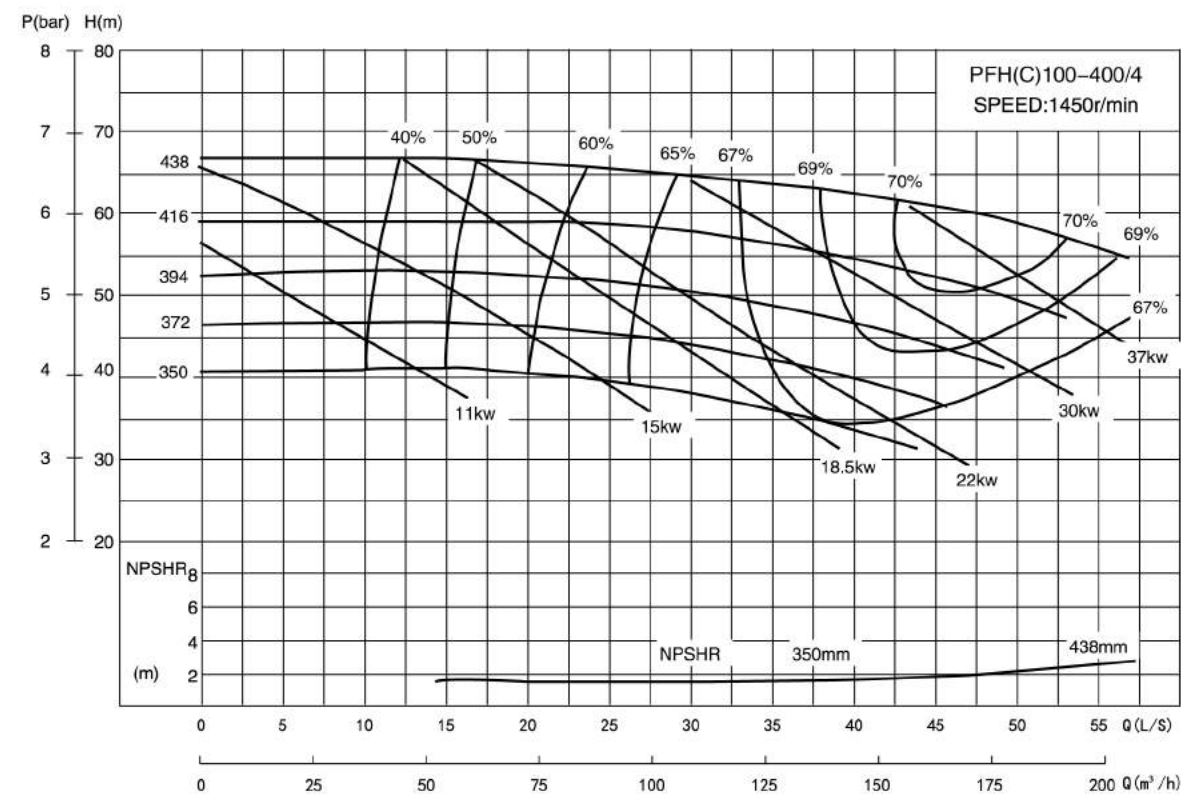

- PFH
- PFHC
- PFH/PFHC32
- PFH/PFHC40
- PFH/PFHC50
- PFH/PFHC65
- PFH/PFHC80
- PFH/PFHC100
- PFH/PFHC125
- PFH/PFHC150
- PFH/PFHC200
- PFH/PFHC250
- PFH/PFHC300
- OTHERS

HORIZONTAL END SUCTION PUMP

PFH/PFHC SERIES / 卧式端吸泵
PFH/PFHC系列

I、PERFORMANCE CURVE CHART 性能曲线图(1450rpm)

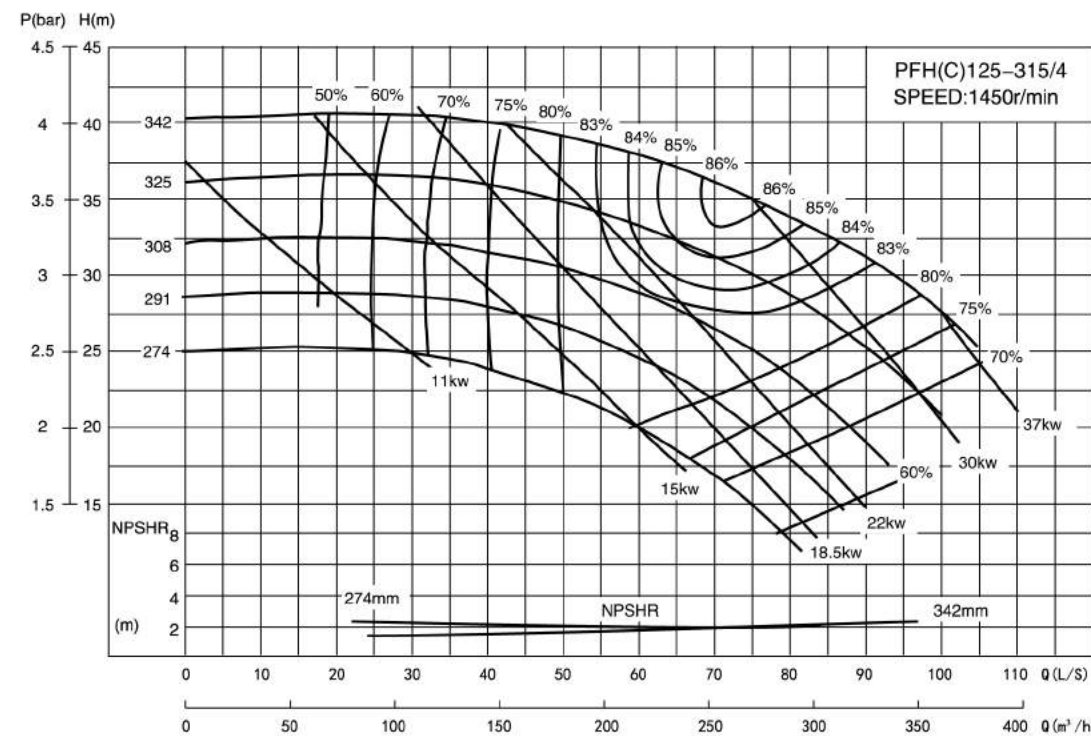
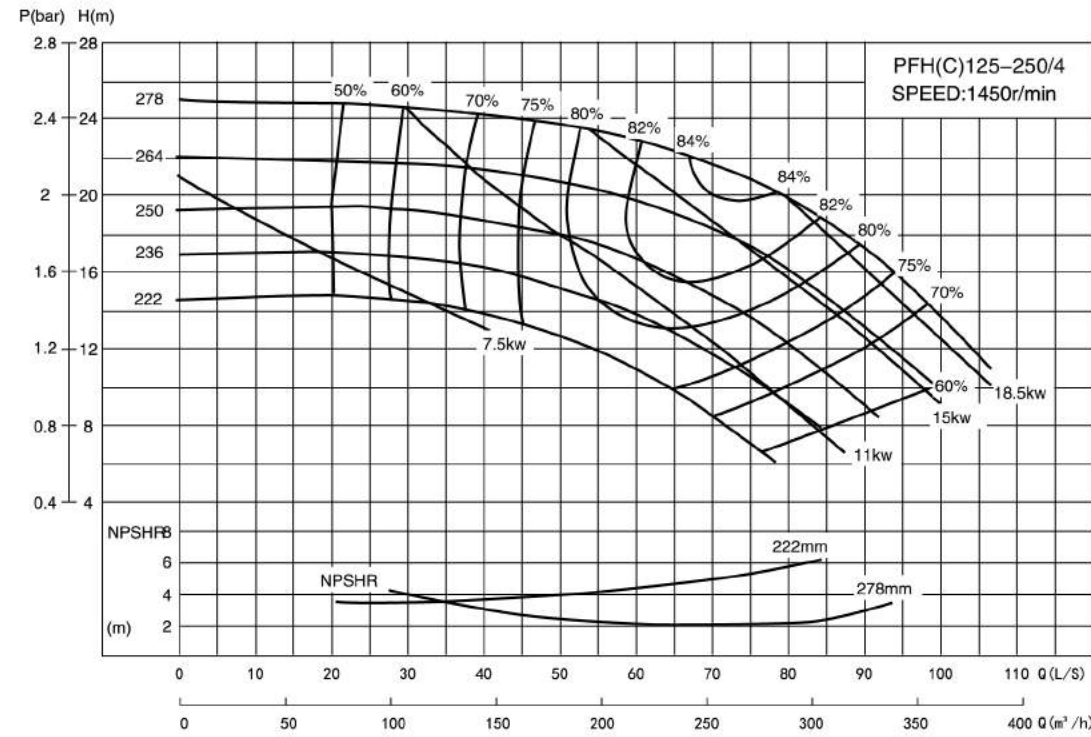

HORIZONTAL END SUCTION PUMP

PFH/PFHC SERIES / 卧式端吸泵
PFH/PFHC系列

I、PERFORMANCE CURVE CHART 性能曲线图(1450rpm)

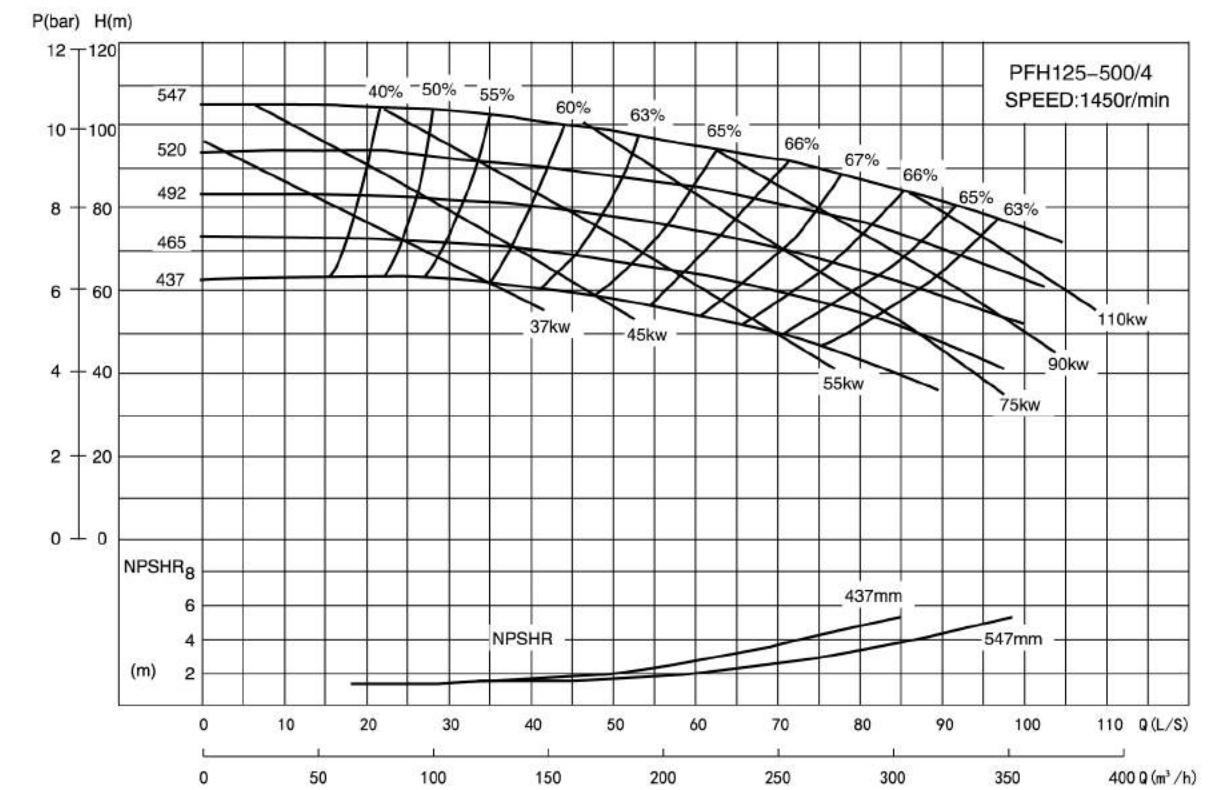
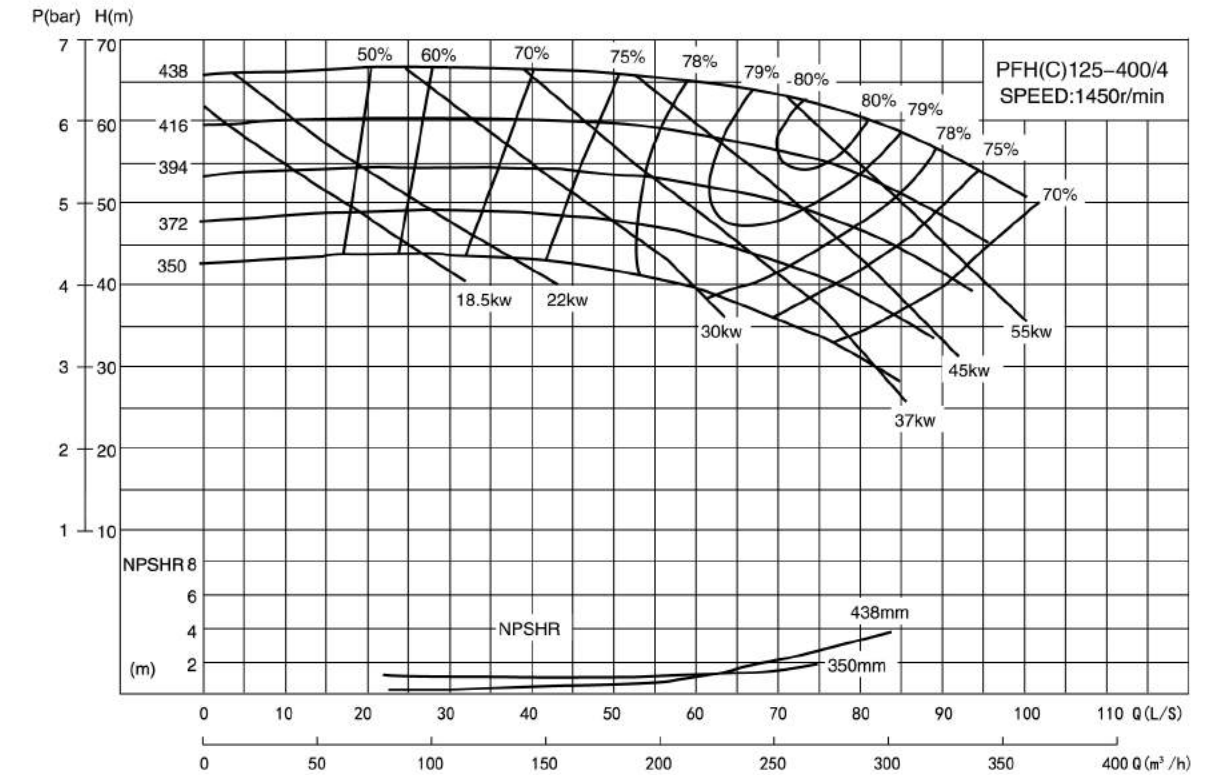

PFH

PFHC

PFH/PFHC32

PFH/PFHC40

PFH/PFHC50

PFH/PFHC65

PFH/PFHC80

PFH/PFHC100

PFH/PFHC125

PFH/PFHC150

PFH/PFHC200

PFH/PFHC250

PFH/PFHC300

OTHERS

HORIZONTAL END SUCTION PUMP

PFH/PFHC SERIES / 卧式端吸泵
PFH/PFHC系列

I、PERFORMANCE CURVE CHART 性能曲线图(1450rpm)

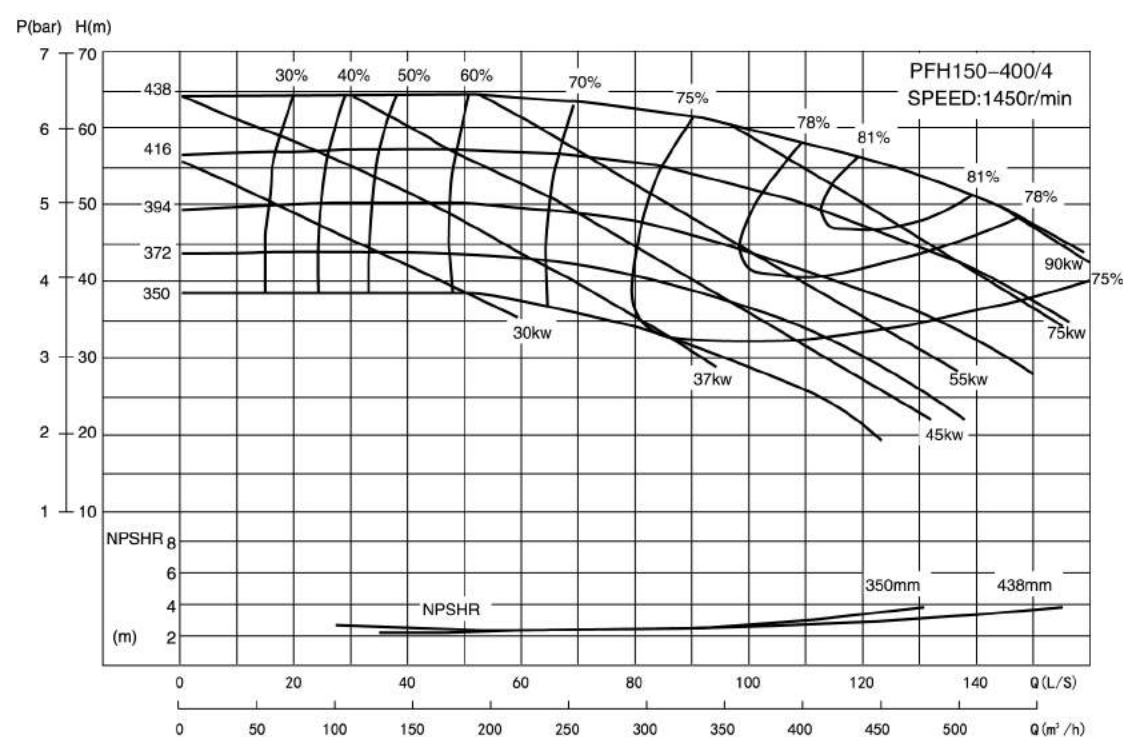
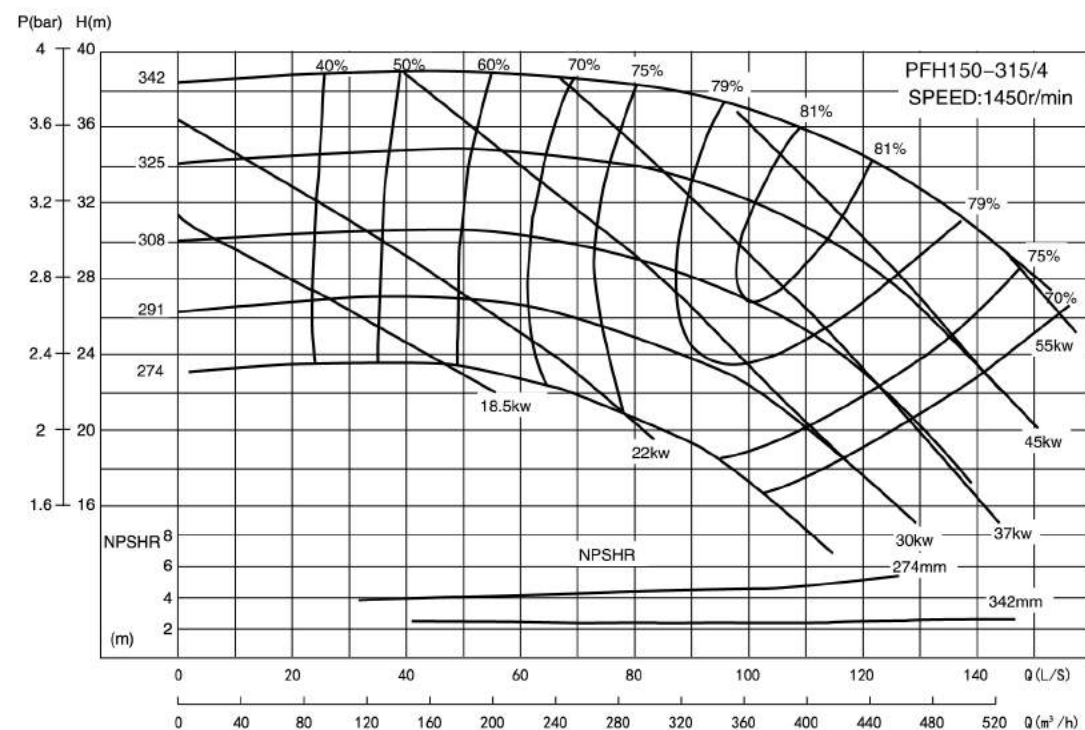

HORIZONTAL END SUCTION PUMP

PFH/PFHC SERIES / 卧式端吸泵
PFH/PFHC系列

I、PERFORMANCE CURVE CHART 性能曲线图(1450rpm)

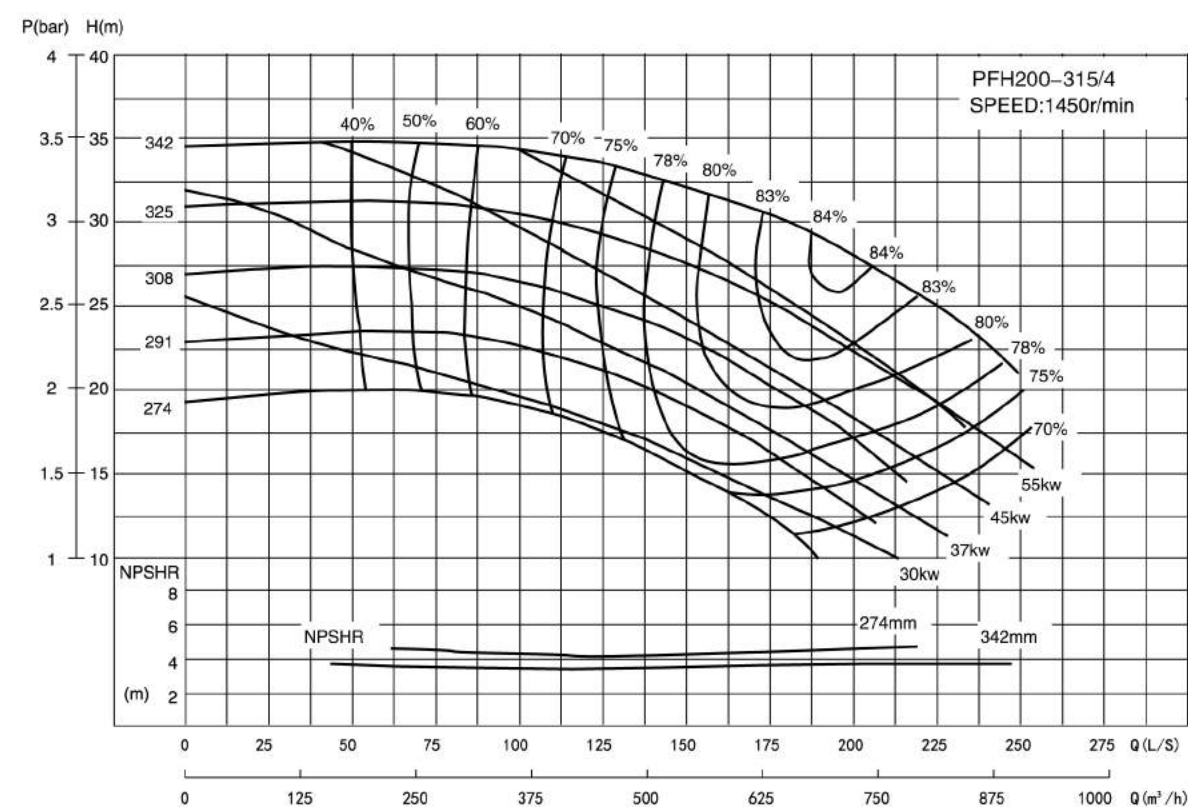
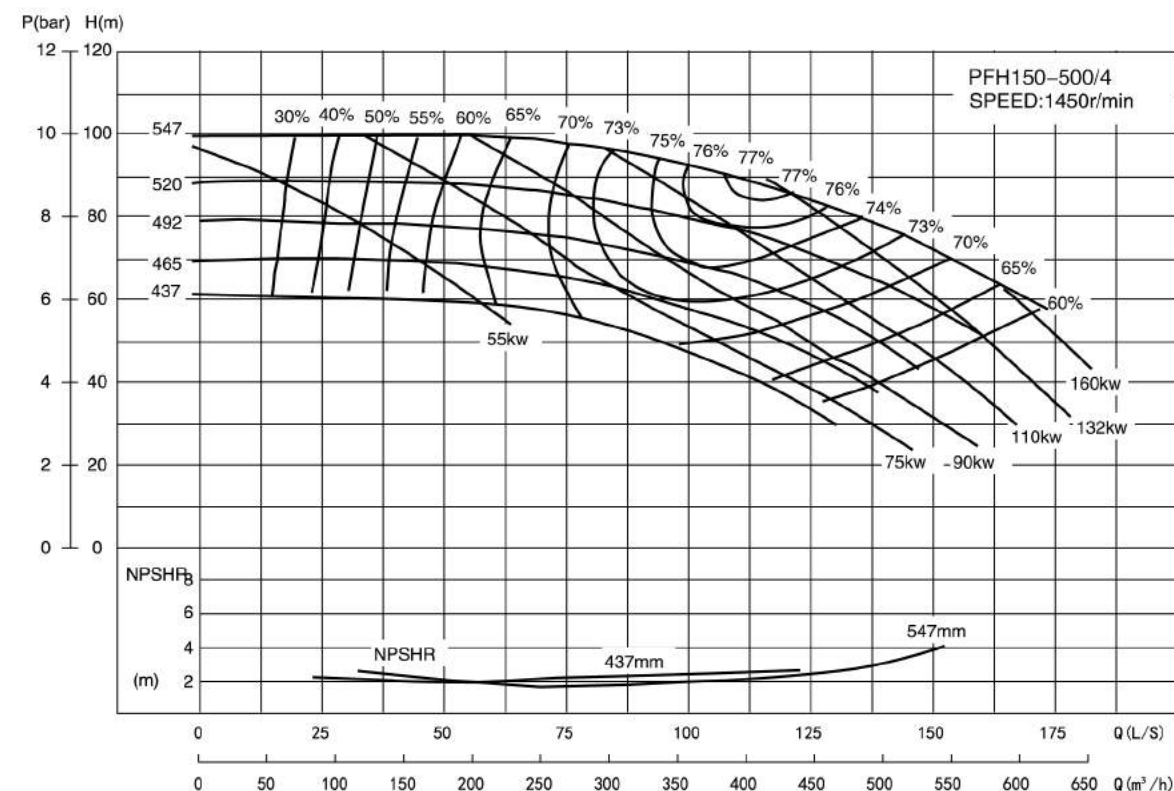

- PFH
- PFHC
- PFH/PFHC32
- PFH/PFHC40
- PFH/PFHC50
- PFH/PFHC65
- PFH/PFHC80
- PFH/PFHC100
- PFH/PFHC125
- PFH/PFHC150
- PFH/PFHC200
- PFH/PFHC250
- PFH/PFHC300
- OTHERS

HORIZONTAL END SUCTION PUMP

PFH/PFHC SERIES / 卧式端吸泵
PFH/PFHC系列

I、PERFORMANCE CURVE CHART 性能曲线图(1450rpm)

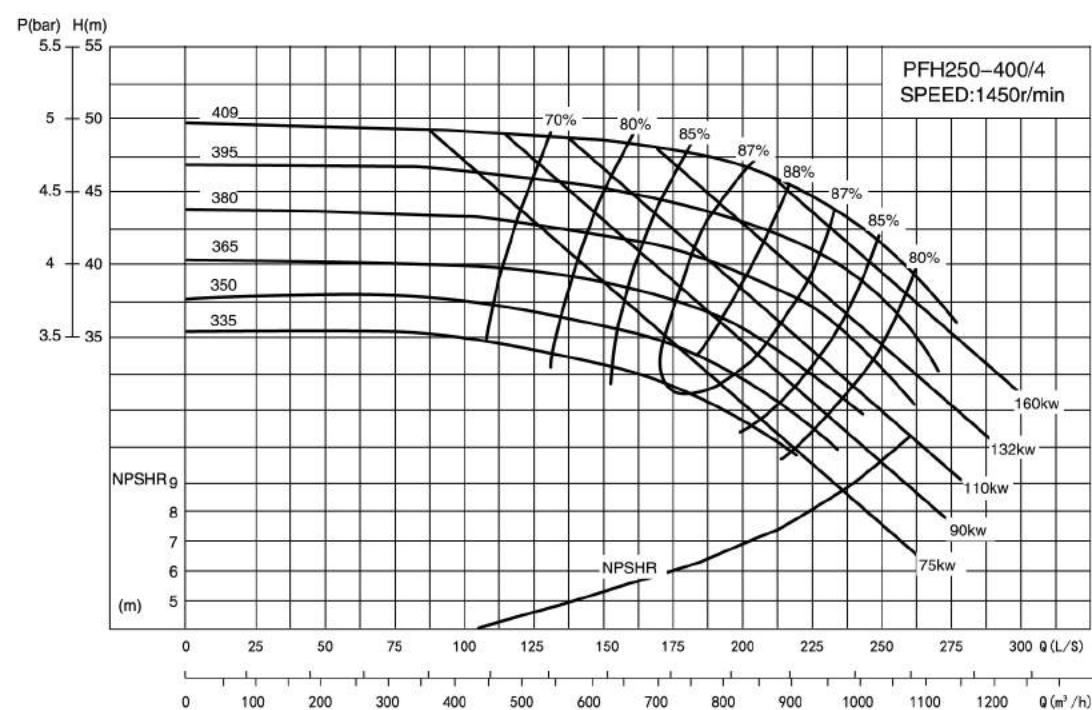
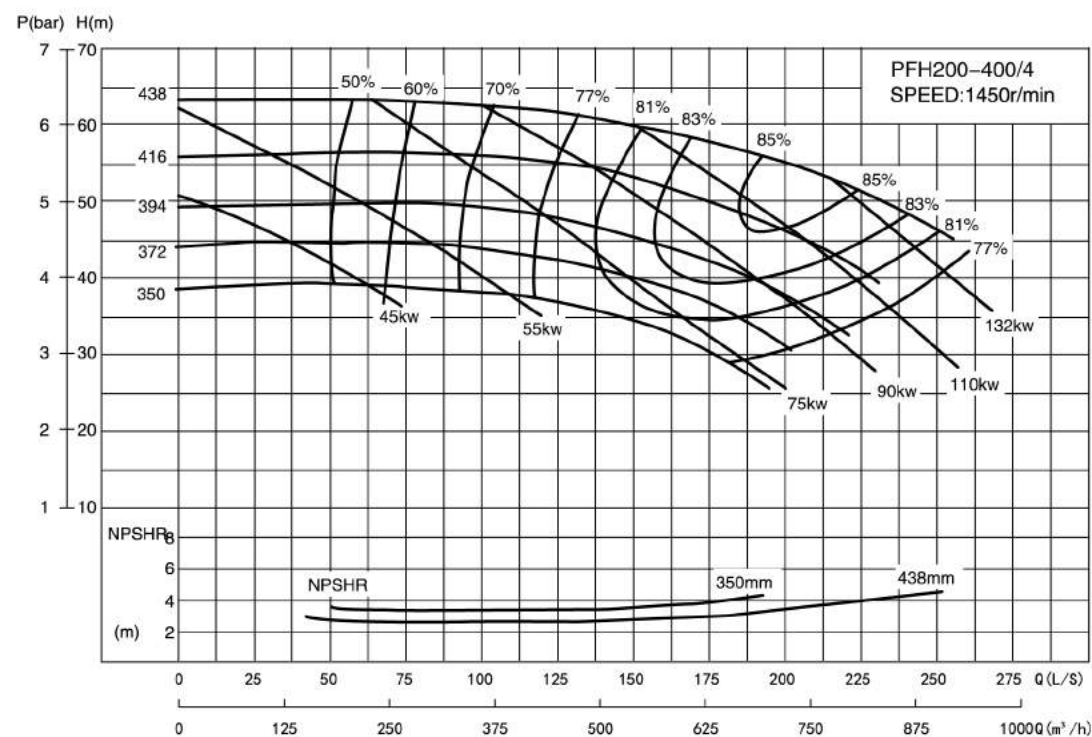

HORIZONTAL END SUCTION PUMP

PFH/PFHC SERIES / 卧式端吸泵
PFH/PFHC系列

I、PERFORMANCE CURVE CHART 性能曲线图(1450rpm)

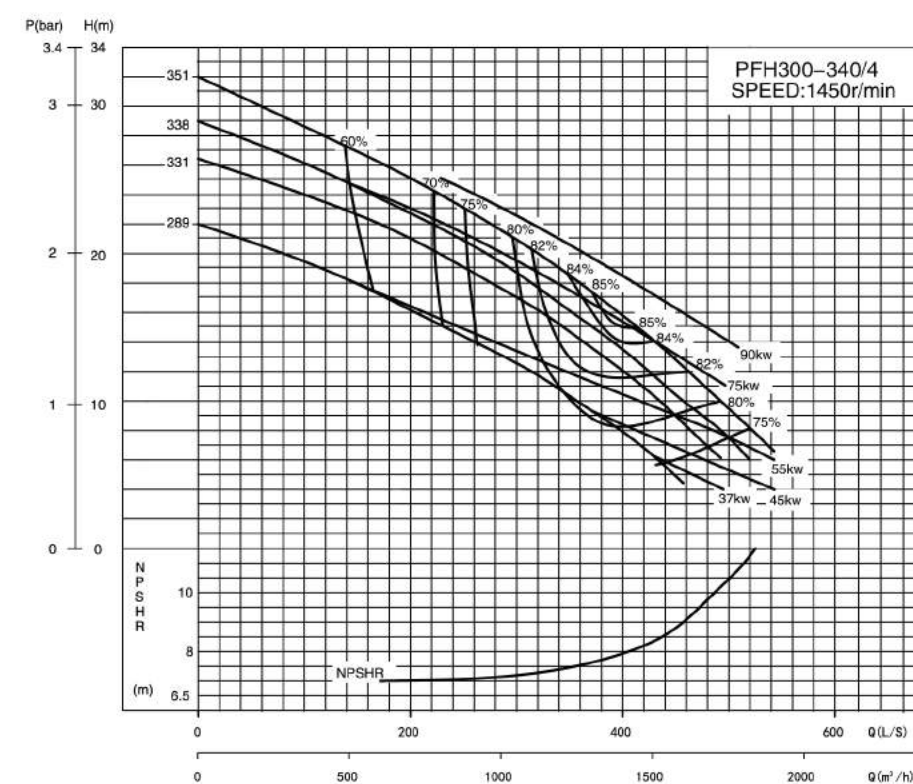
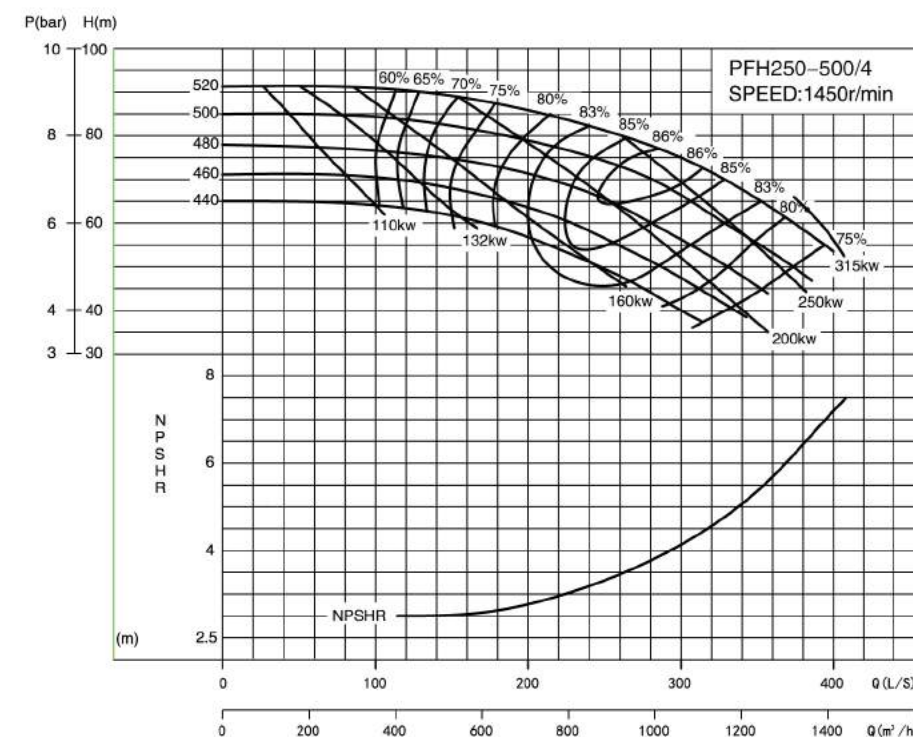

- PFH
- PFHC
- PFH/PFHC32
- PFH/PFHC40
- PFH/PFHC50
- PFH/PFHC65
- PFH/PFHC80
- PFH/PFHC100
- PFH/PFHC125
- PFH/PFHC150
- PFH/PFHC200
- PFH/PFHC250
- PFH/PFHC300
- OTHERS

HORIZONTAL END SUCTION PUMP

PFH/PFHC SERIES / 卧式端吸泵
PFH/PFHC系列

I、PERFORMANCE CURVE CHART 性能曲线图(1450rpm)

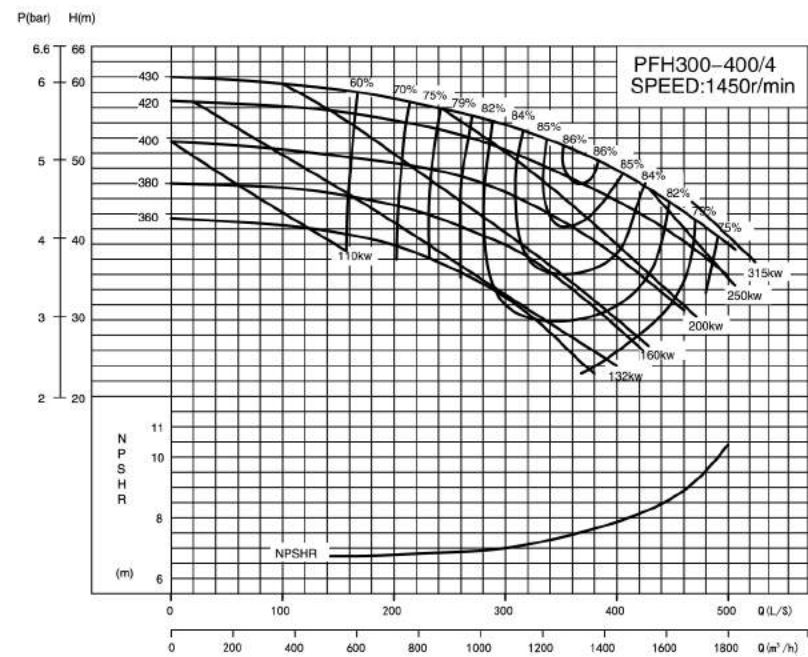
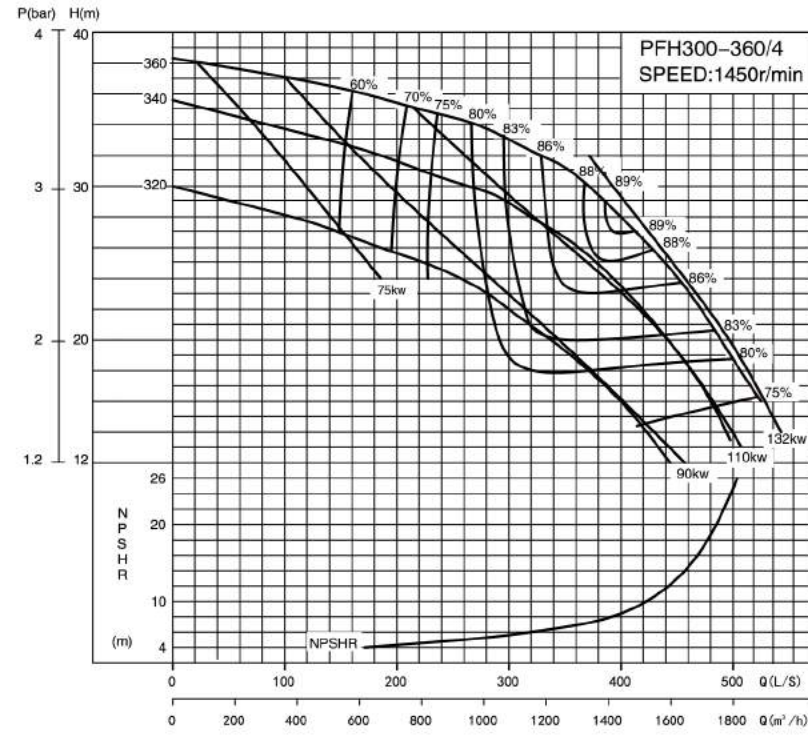

HORIZONTAL END SUCTION PUMP

PFH/PFHC SERIES / 卧式端吸泵
PFH/PFHC系列

I、PERFORMANCE CURVE CHART 性能曲线图(1450rpm)

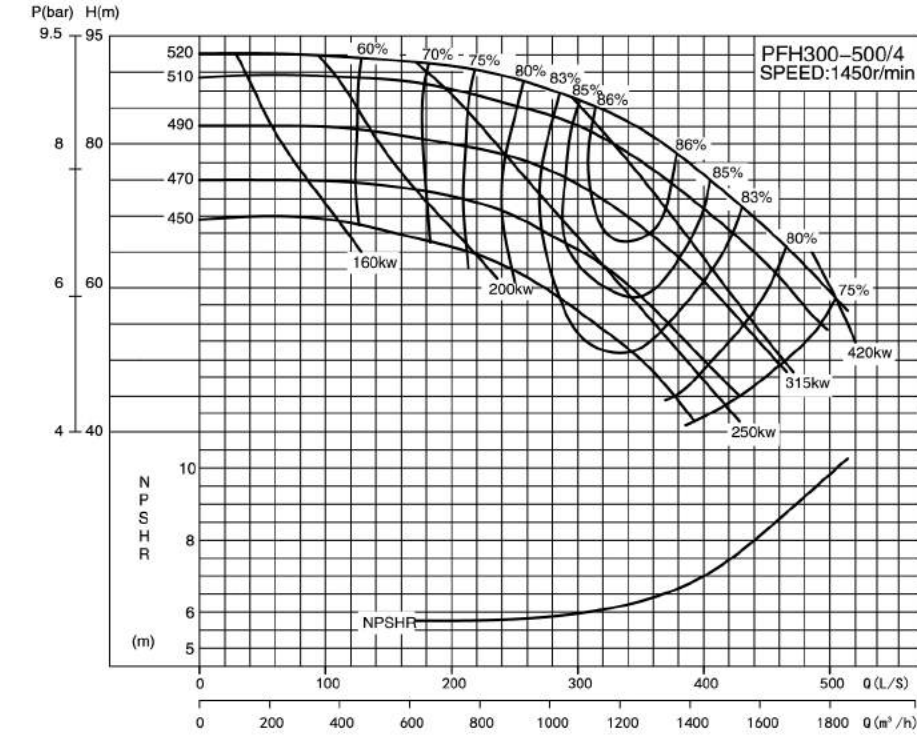

PFH

PFHC

PFH/PFHC32

PFH/PFHC40

PFH/PFHC50

PFH/PFHC65

PFH/PFHC80

PFH/PFHC100

PFH/PFHC125

PFH/PFHC150

PFH/PFHC200

PFH/PFHC250

PFH/PFHC300

OTHERS

HORIZONTAL END SUCTION PUMP

PFH SERIES / 卧式端吸泵
PFH/PFHC系列

II、PUMP OVERALL DLGRAM PFH泵外型尺寸图

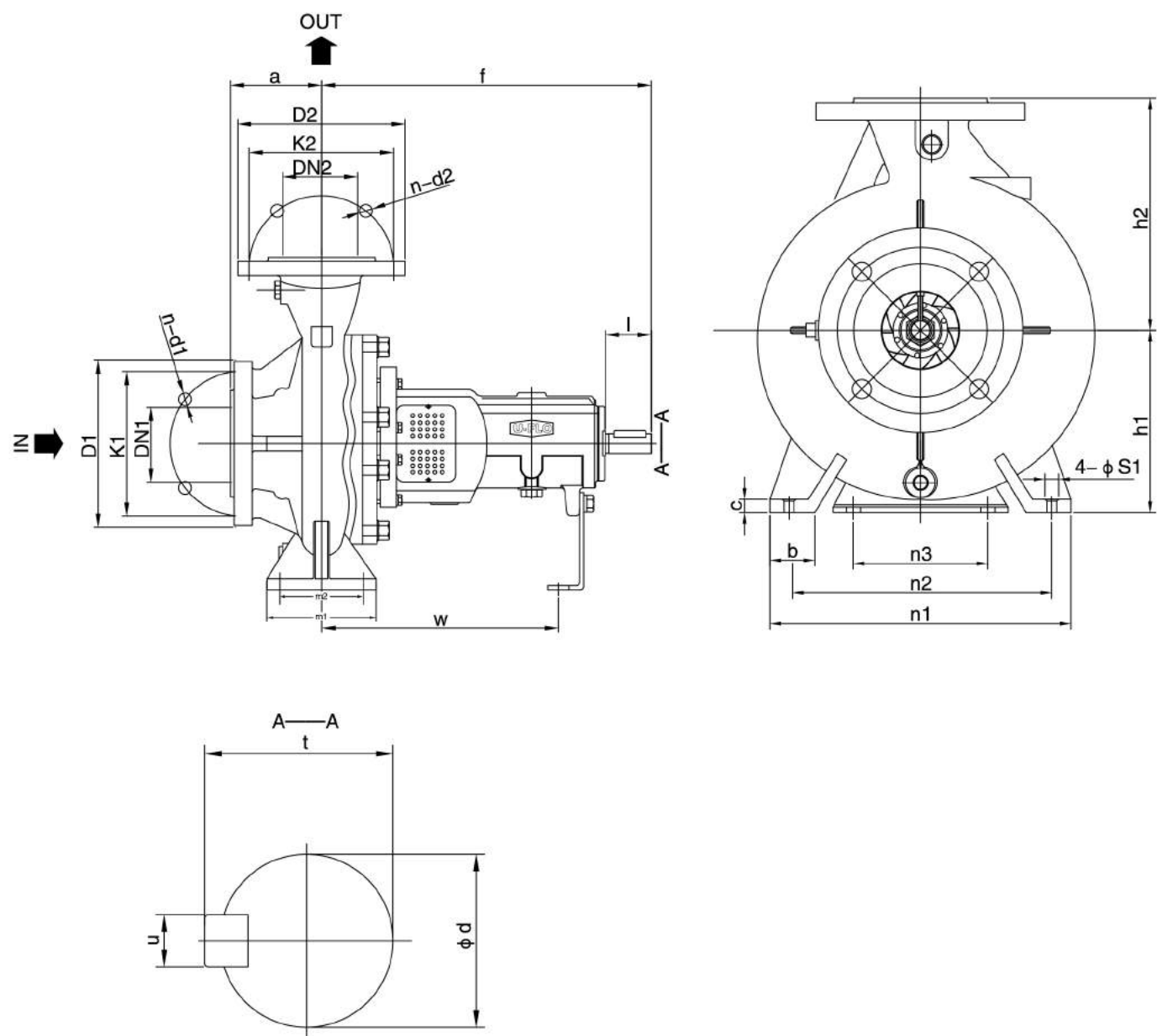

进出口法兰标准尺寸 (ISO7005.2 DIN250) PN16

DN1/DN2	32	40	50	65	80	100	125	150	200	250	300	350
D1/D2	140	150	165	185	200	220	250	285	340	405	460	520
K1/K2	100	110	125	145	160	180	210	240	295	355	410	470
n-d1/n-d2	4-Φ18	4-Φ18	4-Φ18	4-Φ18	8-Φ18	8-Φ18	8-Φ18	8-Φ22	12-Φ22	12-Φ26	12-Φ26	16-Φ26

HORIZONTAL END SUCTION PUMP

PFH SERIES / 卧式端吸泵
PFH/PFHC系列

III、PUMP OVERALL DLGRAM PFH泵外型尺寸表

BASIC PARAMETERS 基本参数

Model 型号	轴承直径	出口DN1	进口DN2	a	f	h1	h2	b	c	n3	m1	m2	n1	n2	S1	w	d	l	t	u	重量kg
PFH32-160	25	32	50	80	360	132	160	50	14	100	100	70	240	190	14	267	24	50	27	8	38
PFH32-200	25	32	50	80	360	160	180	50	14	110	100	70	240	190	14	267	24	50	27	8	46
PFH40-200	25	40	65	100	360	160	180	50	14	110	100	70	265	212	14	267	24	50	27	8	48
PFH40-250	25	40	65	100	360	180	225	65	14	110	125	95	320	250	14	267	24	50	27	8	70
PFH40-315	35	40	65	125	470	200	250	65	14	110	125	95	345	280	14	342	32	80	35	10	80
PFH50-160	25	50	65	100	360	160	180	50	14	110	100	70	265	212	14	267	24	50	27	8	40
PFH50-200	25	50	65	100	360	160	200	50	14	110	100	70	265	212	14	267	24	50	27	8	53
PFH50-250	35	50	65	100	470	225	280	65	14	110	125	95	320	250	14	344	32	80	35	10	75
PFH50-315	35	50	65	100	470	225	280	65	18	110	125	95	345	280	14	342	32	80	35	10	89
PFH65-160	25	65	80	100	360	160	200	65	14	110	125	95	280	212	14	267	24	50	27	8	48
PFH65-200	25	65	80	100	360	180	225	65	14	110	125	95	320	250	14	267	24	80	27	8	72
PFH65-250	35	65	80	100	470	200	250	80	15	110	160	120	360	280	18	342	32	80	35	10	84
PFH65-315	45	65	80	125	525	225	280	80	18	110	160	120	400	315	18	367	42	110	45	12	118
PFH80-160	25	80	100	125	360	180	225	65	14	110	125	95	320	250	14	267	24	50	27	8	68
PFH80-400	45	80	100	125	530	280	355	83	18	110	160	120	440	340	18	370	42	110	45	12	165
PFH100-200	35	100	125	125	470	200	280	80	16	110	160	120	360	280	18	342	32	80	35	10	85
PFH100-250	35	100	125	140	470	225	280	80	16	110	160	120	400	315	18	342	32	80	35	10	126
PFH100-315	35	100	125	140	470	250	315	80	16	110	160	120	400	315	18	342	32	80	35	10	135
PFH100-400	45	100	125	140	530	280	355	100	20	110	200	150	500	400	23	370	42	110	45	12	175
PFH100-500	55	100	125	160	670	355	450	100	25	110	200	150	550	450	23	500	48	110	51	14	314
PFH125-200	35	125	150	140	470	250	315	80	16	110	160	120	400	315	18	342	32	80	35	10	127
PFH125-250	35	125	150	140	470	250	355	80	16	110	160	120	400	315	18	342	32	80	35	10	140
PFH125-315	45	125	150	140	530	280	355	100	18	110	200	150	500	400	23	370	42	110	45	12	150
PFH125-400	45	125	150	140	530	315	400	100	18	110	200	150	500	400	23	370	42	110	45	12	186
PFH125-500	55	125	150	160	670	355	450	100	25	110	200	150	550	450	23	500	48	110	51	14	336
PFH150-315	45	150	200	160	530	280	400	100	18	110	200	150	550	450	23	370	42	110	45	12	222
PFH150-400	45	150	200	160	530	315	450	100	18	110	200	150	550	450	23	370	42	110	45	12	300
PFH150-500	55	150	200	180	670	375	500	100	22	110	200	150	550	450	23	500	48	110	51	14	382
PFH200-315	55	200	250	180	670	315	480	120	20	110	220	170	600	480	28	505	48	110	51	14	277
PFH200-400	55	200	250	180	670	335	480	120	20	110	220	170	600	480	28	505	48	110	51	14	340
PFH250-400	55	250	300	220	682	400	560	150	26	110	250	200	660	510	28	516	48	110	51	14	365
PFH250-500	65	250	300	220	715	500	500	150	32	110	400	325	800	670	35	600	60	140	64	18	412
PFH300-340	65	300	300	255	850	450	450	160	26	140	400	280	700	540	35	715	60	140	64	18	387
PFH300-360	65	300	300	300	717	560	450	160	32	140	400	325	700	540	35	595	60	140	64	18	435
PFH300-400	65	300	350	300	715	560	500	160	32	160	400	325	800	640	35	595	60	140	64	18	483
PFH300-500	65	300	350	300	715	560	500	160	32	160	400	325	800	640	35	600	60	140	64	18	532

HORIZONTAL END SUCTION PUMP

PFH SERIES / 卧式端吸泵
PFH/PFHC系列

IV、PUMP INSTALLATION DIAGRAM PFH泵组安装尺寸图

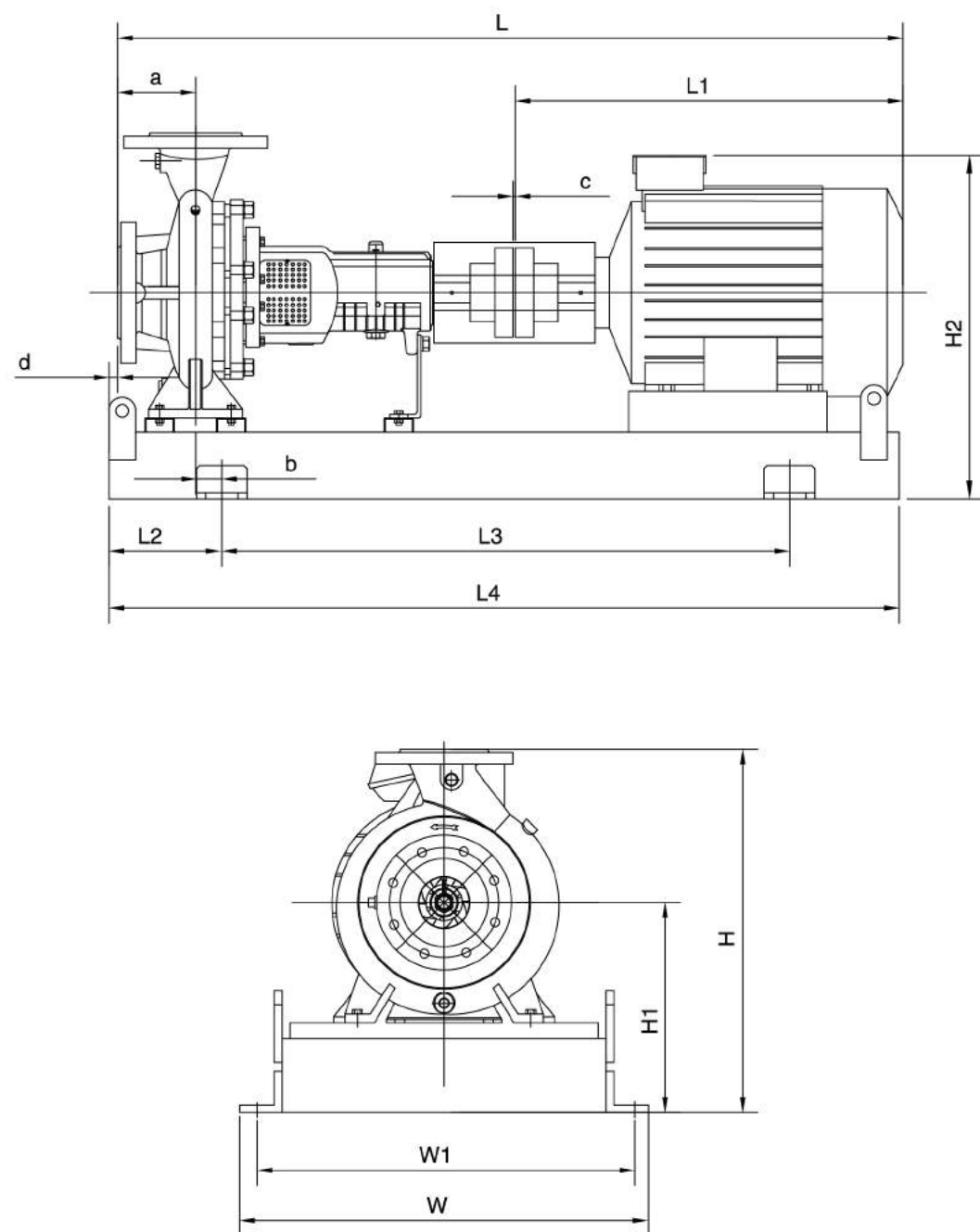

HORIZONTAL END SUCTION PUMP

PFH SERIES / 卧式端吸泵
PFH/PFHC系列

V、PUMP INSTALLATION DIAGRAM PFH泵组安装尺寸表

P=2900rpm

Model 型号	[KW] 功率	a	L	L1	b	L2	L3	L4	W	W1	H	H1	H2	d	c	重量kg
PFHP32-160	3	80	829	385	10	100	530	750	400	357	380	220	390	-10	4	118
	4	80	844	400	10	100	550	770	400	357	380	220	408	-10	4	127
	5.5	80	914	470	10	100	600	820	450	407	380	220	433	-10	4	144
PFHP32-200	5.5	80	934	470	10	100	500	820	450	407	428	248	461	10	4	189
	7.5	80	960	510	10	100	500	820	450	407	428	248	461	10	4	194
	11	80	1079	615	10	100	700	940	500	457	445	265	525	10	4	246
PFHP40-200	7.5	100	934	510	10	125	580	720	450	407	428	258	471	10	4	207
	11	100	1079	615	10	125	700	940	500	457	445	275	535	10	4	258
	15	100	1079	615	10	125	700	940	500	457	445	275	535	10	4	269
PFHP40-250	11	100	1082	670	24	125	660	950	500	457	510	285	545	30	4	276
	15	100	1082	670	24	125	660	950	500	457	510	285	545	30	4	287
	18.5	100	1137	700	24	125	700	990	500	457	510	285	560	30	4	308
PFHP40-315	22	100	1167	740	24	125	720	1000	500	457	510	285	560	30	4	337
	30	100	1212	775	24	125	760	1150	550	507	560	305	615	30	4	405
	22	125	1356	740	22	125	870	1160	500	457	560	305	580	22	4	374
PFHP40-315	30	125	1425	770	22	125	970	1240	550	507	560	310	615	22	4	442
	37	125	1425	820	22	125	970	1240	550	507	560	310	615	22	4	462
	45	125	1470	845	22	125	1000	1280	600	557	585	335	670	22	6	540
PFHP50-160	4	100	864	400	10	100	530	770	400	357	380	220	408	10	4	95
	5.5	100	934	470	10	100	600	820	450	407	380	220	433	10	4	112
	7.5	100	934	510	10	100	600	820	450	407	428	248	461	10	4	117
PFHP50-200	11	100	1082	615	13	100	720	940	500	457	448	248	508	0.5	4	275
	15	100	1082	670	13	100	720	940	500	457	448	248	508	0.5	4	286
	18.5	100	1137	700	10	100	720	990	500	457	448	248	508	0.5	4	306
PFHP50-250	22	100	1167	740	22	125	720	990	500	457	448	248	545	0.5	4	335
	22	100	1167	740	22	125	720	1000	500	457	510	285	560	0.5	4	423
	30	100	1237	770	22	125	800	1070	550	507	535	310	615	0.5	4	445
PFHP50-250	37	100	1237	820	22	125	800	1070	550	507	535	310	615	0.5	4	530
	45	100	1445	845	22	125	1000	1280	600	557	615	335	670	0.5	4	512
	30	125	1425	770	22	125	960	1240	550	507	610	330	635	22	4	510
PFHP50-315	37	125	1425	820	22	125	960	1240	550	507	610	330	635	22	4	552
	45	125	1470	845	22	125	1000	1280	600	557	615	335	670	22	4	630
	55	125	1567	910	22	125	1100	1370	650	607	645	365	730	22	4	695
PFHP65-160	75	125	1642	985	22	125	1190	1440	700	657	675	395	795	22	4	790
	5.5	100	934	470	22	125	550	830	450	407	428	248	461	-2.5	4	168
	7.5	100	934	510	22	125	550	830	450	407	428	248	461	-2.5	4	173
PFHP65-200	11	100	1079	615	22	125	650	950	500	457	445	265	525	-2.5	4	225
	15	100	1079	670	22	125	650	950	500	457	445	265	525	-2.5	4	235
	18.5	100	1239	700	22	125	720	900	500	457	510	285	545	2.5	4	310
PFHP65-200	22	100	1239	740	22	125	720	1000	500	457	510	285	560	2.5	4	345
	30	100	1239	770	22	125	800	1070	550	507	535	310	615	2.5	4	414
	37	100	1239	820	22	125	800	1070	550	507	535	310	615	2.5	4	432

HORIZONTAL END SUCTION PUMP

PFH SERIES / 卧式端吸泵
PFH/PFH系列

V、PUMP INSTALLATION DIAGRAM PFH泵组安装尺寸表

2900r/min																
Model 型号	[KW] 功率	a	L	L1	b	L2	L3	L4	W	W1	H	H1	H2	d	c	重量kg
PFHP65-250	30	100	1341	820	20	140	850	1180	550	507	560	310	615	-20	6	433
	37	100	1341	820	20	140	850	1180	550	507	560	310	615	-20	6	451
	45	100	1391	845	20	140	910	1230	600	557	585	335	670	-20	6	530
	55	100	1488	910	20	140	1000	1320	650	607	615	365	730	-20	6	598
	75	100	1533	985	20	140	1100	1370	700	657	675	395	795	-20	6	713
PFHP65-315	55	125	1565	910	20	140	1050	1390	650	607	645	345	730	5	6	616
	75	125	1641	985	20	140	1100	1450	700	657	675	395	795	5	6	735
	90	125	1698	1035	20	140	1160	1510	700	657	675	395	795	5	6	796
	110	125	1842	1215	20	140	1200	1530	800	757	745	430	960	5	6	1161
PFHP80-160	11	125	1104	670	22	125	660	950	500	457	500	285	545	22	4	208
	15	125	1104	670	22	125	660	950	500	457	500	285	545	22	4	220
	18.5	125	1159	700	22	125	700	990	500	457	510	285	545	22	4	239
	22	125	1189	740	22	125	700	1000	500	457	510	285	560	22	4	308
PFHP100-200	30	125	1370	770	20	140	900	1210	550	507	590	310	615	5	6	430
	37	125	1371	820	20	140	900	1210	550	507	590	310	615	5	6	450
	45	125	1416	845	20	140	910	1230	600	557	615	335	670	5	6	528
	55	125	1513	910	20	140	1000	1230	650	607	645	365	730	5	6	593
	75	125	1586	985	20	140	1050	1400	700	657	675	395	795	5	6	712
PFHP100-250	55	140	1488	910	20	140	1000	1320	650	607	615	365	730	20	6	672
	75	140	1605	985	20	140	1050	1380	700	657	675	395	795	20	6	745
	90	140	1651	1035	20	140	1100	1450	700	657	675	395	795	20	6	802
	110	140	1801	1215	20	140	1150	1480	800	757	710	430	960	20	6	1173
	90	140	1950	1080	20	140	1250	1450	700	657	735	430	795	20	6	838
PFHP100-315	110	140	1950	1240	20	140	1250	1480	800	757	770	455	960	20	6	1206
	132	140	1950	1380	20	140	1250	1540	800	757	800	485	1035	20	6	1310
	160	140	1950	1380	20	140	1250	1540	800	757	800	485	1035	20	6	1375
	160	140	1950	1380	20	140	1250	1540	810	757	800	485	1035	20	6	1445
	200	140	1950	1380	20	140	1250	1540	810	757	800	485	1035	20	6	1495
	250	140	2115	1545	20	140	1400	1710	900	850	820	505	1175	20	6	1613
PFHP100-400	315	140	2115	1545	20	140	1400	1710	900	850	820	505	1175	20	6	1901
	355	140	2115	1545	20	140	1400	1710	900	850	820	505	1175	20	6	2055
	55	140	1680	910	20	140	1060	1750	810	600	715	395	730	25	6	717
	75	140	1725	985	20	140	1060	1750	880	670	715	395	795	25	6	831
	90	140	1790	1035	20	140	1100	1750	880	670	760	430	795	25	6	885
PFHP125-200	110	140	1940	1215	20	140	1100	1800	940	730	760	430	960	25	6	935
	90	140	1790	1035	20	140	1100	1750	880	670	760	430	795	25	6	900
	110	140	1940	1215	20	140	1100	1800	940	730	760	430	960	25	6	1250
	132	140	1950	1380	20	140	1250	1800	940	730	760	430	1035	25	6	1350
	160	140	1950	1380	20	140	1250	1800	940	730	760	430	1035	25	6	1410
PFHP125-250	132	140	1950	1380	20	140	1250	1800	940	730	780	450	1035	25	6	1360
	160	140	1950	1380	20	140	1250	1800	940	730	780	450	1035	25	6	1420
	200	140	1950	1380	20	140	1250	1800	940	730	780	450	1035	25	6	1470
	250	140	2115	1545	20	140	1400	1950	955	740	780	450	1175	25	6	1788

HORIZONTAL END SUCTION PUMP

PFH SERIES / 卧式端吸泵
PFH/PFH系列

VII、PUMP INSTALLATION DIAGRAM PFH泵组安装尺寸表

M=1450RPM																
Model 型号	[KW] 功率	a	L	L1	b	L2	L3	L4	W	W1	H	H1	H2	d	c	重量kg
PFHM32-160	0.55	80	739	295	10	100	480	680	400	357	380	220	360	-10	4	97
	0.75	80	739	295	10	100	480	680	400	357	380	220	360	-10	4	98
PFHM32-200	0.55	80	739	295	10	100	480	680	400	357	380	220	360	10	4	99
	0.75	80	739	295	10	100	480	680	400	357	380	220	360	10	4	100
	1.1	80	764	320	10	100	500	690	400	357	428	248	408	10	4	103
PFHM40-200	1.5	80	789	345	10	100	520	720	400	357	428	248	408	10	4	107
	1.1	100	784	320	10	100	520	720	450	307	428	248	347	10	4	110
	1.5	100	809	345	10	100	530	730	450	307	428	248	408	10	4	120
	2.2	100	851	385	10	100	530	770	450	307	428	248	438	10	4	130
PFHM40-250	1.5	100	809	345	24	125	530	770	450	307	430	248	408	30	4	118
	2.2	100	851	385	24	125	530	770	500	457	493	268	438	30	4	124
	3	100	851	385	24	125	530	770	500	457	493	268	438	30	4	142
PFHM40-315	4	100	867	400	24	125	530	770	500	457	493	268	456	30	4	151
	3	125	851	385	22	125	530	770	500	457	493	268	438	22	4	213
	4	125	867	400	22	125	620	880	500	457	538	288	476	22	4	223
PFHM50-160	5.5	125	937	470	22	125	680	940	500	457	538	288	501	22	4	237
	0.55	100	739	295	10	100	480	680	400	357	380	220	360	10	4	103
	0.75	100	739	295	10	100	480	680	400	357	380	220	360	10	4	106
PFHM50-200	1.1	100	784	320	10	100	500	690	400	357	380	220	380	10	4	108
	1.5	100	812	345	10	100	530	730	450	407	448	248	418	13	4	158
	2.2	100	852	385	10	100	560	760	450	407	448	248	418	13	4	170
PFHM50-250	3	100	852	385	10	100	560	760	500	457	493	268	438	13	4	185
	3	100	852	385	25.5	125	530	770	500	457	493	268	438	0.5	4	233
	4	100	867	400	25.5	125	530	780	500	457	493	268	456	0.5	4	241
PFHM50-315	5.5	100	937	470	25.5	125	570	830	500	457	493	268	481	0.5	4	256
	4	125	999	400	25.5	125	650	880	500	457	593	313	500	22.5	4	230
	5.5	125	1069	470	22.5	125	690	940	500	457	593	313	526	22.5	4	244
PFHM65-160	7.5	125	1109	510	22.5	125	730	980	500	457	593	313	526	22.5	4	257
	0.75	100	791	295	22.5	125	500	690	400	357	380	220	360	-2.5	4	145
	1.1	100	816	320	22.5	125	530	760	400	357	380	220	380	-2.5	4	149
	1.5	100	841	345	22.5	125	560	770	450	407	448	248	418	-2.5	4	153
	3	100	854	385	22.5	125	530	770	500	457	493	268	438	2.5	4	207
PFHM65-200	4	100	869	400	22.5	125	530	780	500	457	493	268	456	2.5	4	216
	5.5	100	940	470	22.5	125	570	830	500	457	493	268	481	2.5	4	232
	4	100	869	400	10	140	700	780	500	457	493	288	456	-20	4	276
PFHM65-250	5.5	100	1084	470	10	140	700	950	500	457	538	288	501	-20	4	292
	7.5	100	1084	510	20	140	680	1000	500	457	538	288	501	-20	4	306
	7.5	125	1044	510	20	140	820	990	550	507	593	313	526	5	4	282
PFHM65-315	11	125	1084	615	20	140	770	1080	550	507	610	330	590	5	4	328
	15	125	1269	670	20	140	680	1120	550	507	610	330	590	5	4	350
	1.5	125	852	385	22.5	125	490	730	450	407	430	248	418	22.5	4	294
PFHM80-160	2.2	125	854	385	22.5	125	530	770	500	457	448	248	438	22.5	4	300
	3	125	1214	385	22.5	125	530	770	5							

HORIZONTAL END SUCTION PUMP

PFH SERIES / 卧式端吸泵 PFH/PFHC系列

VII、PUMP INSTALLATION DIAGRAM PFH泵组安装尺寸表

M=1450RPM																	
Model 型号	[KW] 功率	a	L	L1	b	L2	L3	L4	W	W1	H	H1	H2	d	c	重量kg	
PFHM100-200	4	125	999	400	20	140	620	880	500	457	519	268	456	5	4	282	
	5.5	125	1078	470	20	140	650	960	500	457	555	305	481	5	4	298	
	7.5	125	1109	510	20	140	680	1000	500	457	568	288	501	5	4	305	
PFHM100-250	7.5	140	1214	615	20	140	680	1000	500	457	568	288	501	20	4	290	
	11	140	1229	615	20	140	770	1080	550	507	610	330	590	20	4	338	
	15	140	1284	670	20	140	820	1120	550	507	610	330	590	20	4	360	
PFHM100-315	11	140	1229	615	20	140	770	1080	550	507	670	355	615	20	4	361	
	15	140	1284	670	20	140	800	1120	550	507	670	355	615	20	4	383	
	18.5	140	1314	700	20	140	850	1120	550	507	670	355	630	20	4	419	
PFHM100-400	22	140	1354	740	20	140	870	1160	550	507	670	355	630	20	4	437	
	30	140	1429	770	20	140	960	1260	650	607	740	355	690	20	4	508	
	18.5	140	1314	700	40	140	850	1120	550	507	670	385	670	0	6	510	
PFHM100-500	22	140	1354	740	40	140	870	1160	550	507	670	385	670	0	6	527	
	30	140	1444	770	40	140	950	1280	650	607	740	385	690	0	6	598	
	37	140	1496	820	40	180	1030	1300	650	607	740	385	720	0	6	645	
PFHM100-600	45	140	1521	845	40	180	1100	1340	650	607	740	385	720	0	6	680	
	45	160	1546	845	50	200	1100	1340	700	657	740	385	720	20	6	694	
	55	160	1608	910	50	200	1100	1400	700	657	870	420	785	20	6	710	
PFHM100-750	75	160	1681	985	50	200	1100	1470	700	657	870	420	820	20	6	790	
	90	160	1733	1035	50	200	1100	1520	700	657	870	420	820	20	6	854	
	11	140	1234	615	20	140	800	1120	550	507	710	355	615	20	4	349	
PFHM125-250	15	140	1284	670	20	140	800	1120	550	507	710	355	615	20	4	370	
	18.5	140	1314	700	20	140	800	1120	550	507	710	355	630	20	4	405	
	22	140	1354	740	20	140	850	1160	550	507	710	355	630	20	4	426	
PFHM125-315	18.5	140	1374	700	40	180	900	1200	650	607	740	385	660	0	4	496	
	22	140	1414	740	40	180	910	1240	650	607	740	385	660	0	4	510	
	30	140	1444	770	40	180	950	1280	650	607	740	385	690	0	4	570	
PFHM125-400	37	140	1521	820	40	180	1000	1320	650	607	740	385	690	0	4	625	
	37	140	1521	820	40	200	1000	1320	650	607	785	385	720	20	6	687	
	45	140	1541	845	40	200	1000	1350	650	607	820	420	755	20	6	710	
PFHM125-500	55	140	1606	910	60	200	1030	1400	650	607	820	420	785	20	6	785	
	75	140	1681	985	60	200	1100	1470	700	657	820	420	820	20	6	930	
	75	160	1842	985	50	200	1200	1620	750	707	920	440	840	30	6	950	
PFHM125-600	90	160	1892	1035	50	200	1240	1680	750	707	920	440	840	30	6	1011	
	110	160	2072	1215	50	200	1340	1740	800	757	920	440	970	30	6	1370	
	132	160	2182	1325	50	200	1390	1790	800	757	920	440	970	30	6	1475	
PFHM150-315	30	160	1471	770	40	180	950	1270	680	637	785	385	720	25	6	600	
	37	160	1521	820	40	180	1000	1320	680	637	785	385	720	25	6	665	
	45	160	1546	845	40	180	1000	1350	680	637	785	385	720	25	6	700	
PFHM150-400	55	160	1611	910	60	200	1030	1400	680	637	785	385	750	25	6	785	
	75	160	1683	985	60	200	1080	1470	700	657	785	385	820	25	6	877	
	45	160	1546	845	60	200	1000	1350	700	657	870	420	750	20	6	850	
PFHM150-500	55	160	1608	910	60	200	1000	1400	700	657	870	420	785	20	6	860	
	75	160	1683	985	60	200	1080	1470	700	657	870	420	820	20	6	990	
	90	160	1733	1035	60	200	1080	1520	700	657	870	420	820	20	6	1010	
	110	160	1892	1215	60	200	1240	1680	700	657	920	220	970	20	6	1367	

HORIZONTAL END SUCTION PUMP

PFH SERIES / 卧式端吸泵 PFH/PFHC系列

VII、PUMP INSTALLATION DIAGRAM PFH泵组安装尺寸表

1450r/min																	
Model 型号	[KW] 功率	a	L	L1	b	L2	L3	L4	W	W1	H	H1	H2	d	c	重量kg	
PFHM150-500	75	180	1842	985	50	200	1200	1620	750	707	920	440	840	30	6	1018	
	90	180	1892	1035	50	200	1240	1680	750	707	920	440	840	30	6	1030	
	110	180	2072	1215	50	200	1340	1740	800	757	920	440	970	30	6	1385	
PFHM200-315	132	180	2182	1325	50	200	1390	1790	800	757	920	440	970	30	6	1490	
	160	180	2233	1325	50	200	1500	1870	800	757	920	440	970	30	6	1515	
	30	180	1471	770	60	200	980	1280	700	657	900	420	720	30	6	755	
PFHM200-400	37	180	1676	820	60	200	1070	1470	700	657	900	420	755	30	6	810	
	45	180	1700	845	60	200	1100	1500	700	657	900	420	755	30	6	840	
	55	180	1766	910	60	200	1200	1550	700	657	900	420	785	30	6	915	
PFHM200-500	75	180	1841	985	60	200	1230	1620	720	657	900	420	820	30	6	1050	
	75	180	1842	985	60	200	1200	1620	750	707	920	440	840	30	6	1130	
	90	180	1892	1035	60	200	1240	1680	750	707	920	440	840	30	6	1150	
PFHM250-400	110	180	2072	1215	60	200	1340	1740	800	757	920	440	970	30	6	1475	
	132	180	2182	1325	60	200	1390	1790	800	757	920	440	970	30	6	1630	
	160	180	2233	1325	60	200	1500	1870	800	757	920	440	970	30	6	1720	
PFHM250-500	90	220	1943	1035	35	200	1350	1700	800	757	1065	505	905	55	6	1195	
	110	220	2123	1215	35	200	1390	1760	800	757	1065	505	1035	55	6	1515	
	132	220	2233	1325	35	200	1500	1870	800	757	1065	505	1035	55	6	1670	
PFHM300-340	160	220	2233	1325	35	200	1500	1870	800	757	1065	505	1035	55	6	1760	
	200	220	2233	1325	35	200	1500	1870	800	757	1065	505	1035	55	6	1810	
	160	225	2275	1330	10	230	1500	2055	860	810	1190	690	1245	55	6	1827	
PFHM300-360	200	225	2275	1330	10	230	1500	2055	860	810	1190	690	1245	55	6	1877	
	250	225	2510	1565	10	230	1700	2290	860	810	1190	690	1345	55	6	2323	
	315	225	2510	1565	10	230	1700	2290	860	810	1190	690	1345	55	6	2598	
PFHM300-400	355	225	2510	1565	10	230	1700	2290	860	810	1190	690	1345	55	6	2670	
	45	255	1950	840	25	220	1150	1730	860	810	1070	620	975	55	6	960	
	55	255	2040	930	25	220	1240	1820	860	810	1070	620	1015	55	6	970	
PFHM300-500	75	255	2085	975	25	220	1290	1865	860	810	1090	640	1075	55	6	1230	
	90	255	2150														

HORIZONTAL END SUCTION PUMP

PFHC SERIES / 卧式端吸泵 PFH/PFHC系列

VII、PUMP INSTALLATION DIAGRAM PFHC泵组安装尺寸图

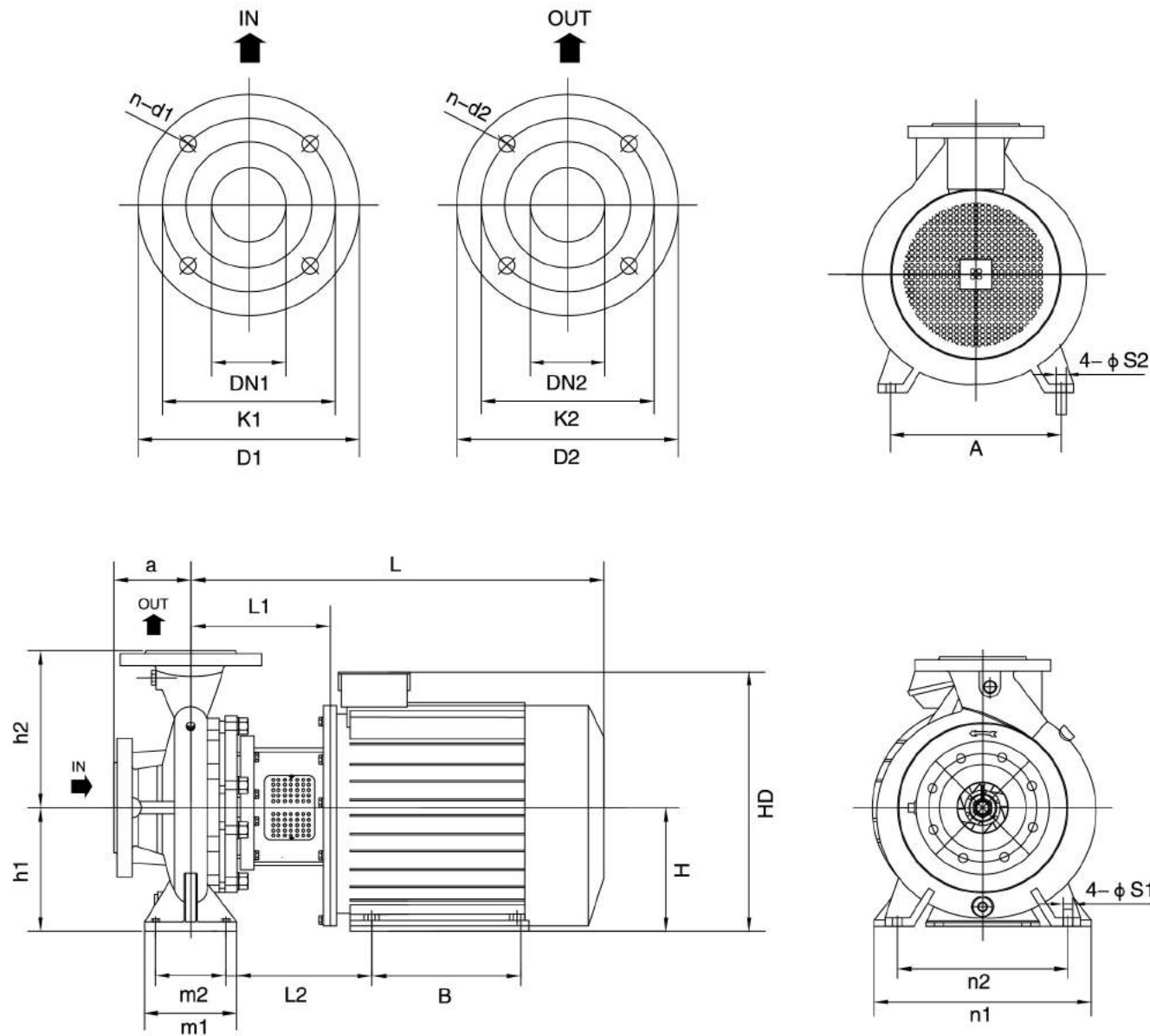

HORIZONTAL END SUCTION PUMP

PFHC SERIES / 卧式端吸泵 PFH/PFHC系列

IX、PUMP INSTALLATION DIAGRAM PFHC泵组安装尺寸表

P=2900rpm

Model 型号	[KW] 功率	a	h1	h2	L1	L2	L	A	B	H	HD	m1	m2	n1	n2	S1	S2	重量kg
PFHCP32-160	3	80	132	160	164	192	489	160	140	100	270	100	70	240	190	14	12	75
	4	80	132	160	164	199	504	190	140	112	300	100	70	240	190	14	12	80
	5.5	80	132	160	187	241	577	216	140	132	345	100	70	240	190	14	12	98
PFHCP32-200	5.5	80	160	180	186	240	576	216	140	132	345	100	70	240	190	14	12	105
	7.5	80	160	180	186	240	576	216	140	132	345	100	70	240	190	14	12	110
	11	80	160	180	218	291	723	254	210	160	420	100	70	240	190	14	15	158
PFHCP40-200	7.5	100	160	180	186	240	576	216	140	132	345	100	70	265	212	14	12	112
	11	100	160	180	218	291	723	254	210	160	420	100	70	265	212	14	15	160
	15	100	160	180	218	291	723	254	254	160	420	100	70	265	212	14	15	170
PFHCP40-250	11	100	180	225	228	287	733	254	241	160	420	125	95	320	250	14	15	182
	15	100	180	225	228	287	733	254	254	160	420	125	95	320	250	14	15	192
	18.5	100	180	225	228	287	788	254	254	160	420	125	95	320	250	14	15	212
PFHCP40-315	22	100	180	225	228	300	818	279	241	180	455	125	95	320	250	14	15	240
	30	100	180	225	228	315	892	318	305	200	505	125	95	320	250	14	19	305
	22	125	200	250	231	292	861	279	241	180	455	125	95	345	280	14	15	250
PFHCP50-160	30	125	200	250	237	323	897	318	305	200	505	125	95	345	280	14	19	315
	37	125	200	250	237	323	897	318	305	200	505	125	95	345	280	14	19	335
	45	125	200	250	237	339	942	356	311	225	560	125	95	345	280	14	19	408
PFHCP50-200	4	100	160	180	187	241	577	216	140	132	345	100	70	265	212	14	12	82
	5.5	100	160	180	187	241	577	216	140	132	345	100	70	265	212	14	12	98
	7.5	100	160	180	187	241	577	216	140	132	345	100	70	265	212	14	12	103
PFHCP50-250	11	100	160	200	221	291	726	254	210	160	420	100	70	265	212	14	15	165
	15	100	160	200	221	291	726	254	210	160	420	100	70	265	212	14	15	175
	18.5	100	160	200	221	291	781	254	254	160	420	100	70	265	212	14	15	195
PFHCP50-315	22	100	160	200	221	291	819	279	279	180	455	100	70	265	212	14	15	223
	22	100	180	225	229	300	819	279	241	180	455	125	95	320	250	14	15	245
	30	100	180	225	232	315	892	318	305	200	505	125	95	320	250	14	19	310
PFHCP50-350	37	100	180	225	232	315	892	318	305	200	505	125	95	320	250	14	19	330
	45	100	180	225	237	339	942	356	311	225	560	125	95	320	250	14	19	405
	30	125	225	280	237	323	897	318	305	200	505	125	95	345	280	14	19	325
PFHCP50-400	37	125	225	280	237	323	897	318	305	200	505	125	95	345	280	14	19	350
	45	125	225	280	237	339	942	356	311	225	560	125	95	345	280	14	19	420
	55	125	225	280	273	394	1043	406	349	250	615	125	95	345	280	14	24	480
PFHCP65-160	75	125	225	280	273	416	1118	457	368	280	680	125	95	345	280	14	24	595
	5.5	100	160	200	187	229	577	215	140	132	345	125	95	280	212	14	12	108
	7.5	100	160	200	187	229	577	215	140	132	345	125	95	280	212	14	12	115
PFHCP65-200	11	100	160	200	220	281	725	254	210	160	420	125	95	280	212	14	15	163
	15	100	160	200	220	281	725	254	210	160	420	125	95	280	212	14	15	175
	18.5	100	180	225	218	279	778	254	254	160	420	125	95	320	250	14	15	215
PFHCP65-250	22	100	180	225	218	292	808	279	241	180	455	125	95	320	250	14	15	242
	30	100	180	225	221	307	881	318	305	200	505	125	95	320	250	14	19	308
	37	100	180	225	221	307	881	318	305	200	505	125	95	320	250	14	19	328

HORIZONTAL END SUCTION PUMP

PFHC SERIES / 卧式端吸泵
PFH/PFHC系列

IX、PUMP INSTALLATION DIAGRAM PFHC泵组安装尺寸表

P=2900rpm

Model 型号	[KW] 功率	a	h1	h2	L1	L2	L	A	B	H	HD	m1	m2	n1	n2	S1	S2	重量kg
PFHCP65-250	30	100	200	250	237	310	897	318	305	200	505	160	120	360	280	18	19	320
	37	100	200	250	237	310	897	318	305	200	505	160	120	360	280	18	19	340
	45	100	200	250	237	326	942	356	311	225	560	160	120	360	280	18	19	415
	55	100	200	250	271	379	1041	406	349	250	615	160	120	360	280	18	24	475
	75	100	200	250	271	379	1041	457	368	280	680	160	120	360	280	18	24	610
PFHCP65-315	55	125	225	280	272	380	1042	406	349	250	615	160	120	400	315	18	24	515
	75	125	225	280	272	402	1117	457	368	280	680	160	120	400	315	18	24	630
	90	125	225	280	272	402	1167	457	419	280	680	160	120	400	315	18	24	685
	110	125	225	280	272	409	1322	508	406	315	870	160	120	400	315	18	24	1035
PFHCP80-160	11	125	180	225	220	281	725	254	210	160	420	125	95	320	250	14	15	185
	15	125	180	225	220	281	725	254	210	160	420	125	95	320	250	14	15	197
	18.5	125	180	225	220	281	780	254	254	160	420	125	95	320	250	14	15	220
	22	125	180	225	220	294	810	279	241	180	455	125	95	320	250	14	15	240
PFHCP100-200	30	125	200	280	237	310	897	318	305	200	505	160	120	360	280	18	19	325
	37	125	200	280	237	310	897	318	305	200	505	160	120	360	280	18	19	345
	45	125	200	280	237	310	942	356	311	225	560	160	120	360	280	18	19	418
	55	125	200	280	271	379	1041	406	349	250	615	160	120	360	280	18	24	480
	75	125	200	280	271	401	1116	457	368	280	680	160	120	360	280	18	24	595
PFHCP100-250	55	140	225	280	275	383	1045	406	349	250	615	160	120	400	315	18	24	520
	75	140	225	280	275	405	1120	457	368	280	680	160	120	400	315	18	24	635
	90	140	225	280	275	405	1170	457	419	280	680	160	120	400	315	18	24	690
	110	140	225	280	275	409	1322	508	406	315	870	160	120	400	315	18	24	1040
PFHCP100-315	90	140	250	280	275	409	1170	457	419	280	680	180	140	540	457	24	35	700
	110	140	250	280	275	409	1322	508	406	315	870	180	140	540	457	24	35	1050
	132	140	250	280	275	409	1435	508	457	315	870	180	140	540	457	24	35	1150
	160	140	250	280	275	409	1435	508	508	315	870	180	140	540	457	24	35	1210

HORIZONTAL END SUCTION PUMP

PFHC SERIES / 卧式端吸泵
PFH/PFHC系列

IX、PUMP INSTALLATION DIAGRAM PFHC泵组安装尺寸表

M=1450rpm

Model 型号	[KW] 功率	a	h1	h2	L1	L2	L	A	B	H	HD	m1	m2	n1	n2	S1	S2	重量kg
PFHCM32-160	0.55	80	132	160	152	167	407	125	100	80	220	100	70	240	190	14	10	54
	0.75	80	132	160	152	167	407	125	100	80	220	100	70	240	190	14	10	55
PFHCM32-200	0.55	80	160	180	151	166	406	125	100	80	220	100	70	240	190	14	10	62
	0.75	80	160	180	151	166	406	125	100	80	220	100	70	240	190	14	10	63
	1.1	80	160	180	151	172	421	140	100	90	250	100	70	240	190	14	10	67
	1.5	80	160	180	151	172	446	140	125	90	250	100	70	240	190	14	10	71
PFHCM40-200	1.1	100	160	180	151	172	421	140	100	90	250	100	70	265	212	14	10	69
	1.5	100	160	180	151	172	446	140	125	90	250	100	70	265	212	14	10	73
	2.2	100	160	180	173	187	498	160	140	100	270	100	70	265	212	14	10	81
	1.5	100	180	225	151	172	446	160	140	100	270	125	95	320	250	14	12	95
PFHCM40-250	2.2	100	180	225	173	187	498	160	140	100	270	125	95	320	250	14	12	103
	3	100	180	225	173	187	498	160	140	100	270	125	95	320	250	14	12	106
	4	100	180	225	179	202	504	190	140	112	300	125	95	320	250	14	12	115
	3	125	200	250	179	195	504	160	140	100	270	125	95	345	280	14	12	116
PFHCM40-315	4	125	200	250	179	202	519	190	140	112	300	125	95	345	280	14	12	125
	5.5	125	200	250	201	243	591	216	140	132	345	125	95	345	280	14	12	140
	0.55	100	160	180	152	167	407	125	100	80	220	100	70	265	212	14	10	56
PFHCM50-160	0.75	100	160	180	152	167	407	125	100	80	220	100	70	265	212	14	10	57
	1.1	100	160	180	152	173	422	140	100	90	250	100	70	265	212	14	10	61
	1.5	100	160	200	154	172	449	140	125	90	250	100	70	265	212	14	10	78
PFHCM50-200	2.2	100	160	200	166	191	491	160	140	100	270	100	70	265	212	14	12	86
	3	100	160	200	174	187	497	160	140	100	270	100	70	265	212	14	12	89
	3	100	180	225	174	187	497	160	140	100	270	125	95	320	250	14	12	111
PFHCM50-250	4	100	180	225	174	194	512	190	140	112	300	125	95	320	250	14	12	120
	5.5	100	180	225	197	236	587	216	178	132	345	125	95	320	250	14	12	135
	4	125	225	280	179	202	519	190	140	112	300	125	95	320	250	14	12	135
PFHCM50-315	5.5	125	225	280	201	243	591	216	140	132	345	125	95	345	280	14	12	150
	7.5	125	225	280	201	243	631	216	178	132	345	125	95	345	280	14	12	163
PFHCM65-160	0.75	100	160	200	152	149	407	125	100	80	220	125	95	280	212	14	10	65
	1.1	100	160	200	152	155	422	140	100	90	250	125	95	280	212	14	10	69
	1.5	100	160	200	152	155	447	140	125	90	250	125	90	280	212	14	10	73
PFHCM65-200	3	100	180	225	163	179	488	160	140	100	270	125	95	320	250	14	12	108
	4	100	180	225	163	186	503	190	140	112	300	125	95	320	250	14	12	117
	5.5	100	180	225	197	236	587	216	140	132	345	125	95	320	250	14	12	132
PFHCM65-250	4	100	200	250	179	189	519	190	140	112	300	160	120	360	280	18	12	130
	5.5	100	200	250	202	231	592	216	140	132	345	160	120	360	280	18	12	145
	7.5	100	200	250	202	231	632	216	178	132	345	160	120	360	280	18	12	157
PFHCM65-315	7.5	125	225	280	201	230	631	216	178	132	345	160	120	400	315	18	12	193
	11	125	225	280	235	283	740	254	210	160	420	160	120	400	315	18	15	236
	15	125	225	280	235	283	795	254	254	160	420	160	120	400	315	18	15	257
PFHCM80-160	1.5	125	180	225	152	155	447	140	125	90	250	125	95	320	250	14	12	95
	2.2	125	180	225	164	180	489	160	140	100	270	125	95	320	250	14	12	103
	3	125	180	225	164	180	489	160	140	100	270	125	95	320	250	14	12	106

PFH
PFHC
PFH/PFHC32
PFH/PFHC40
PFH/PFHC50
PFH/PFHC65
PFH/PFHC80
PFH/PFHC100
PFH/PFHC125
PFH/PFHC150
PFH/PFHC200
PFH/PFHC250
PFH/PFHC300
OTHERS

HORIZONTAL END SUCTION PUMP

PFHC SERIES / 卧式端吸泵
PFH/PFHC系列

IX、PUMP INSTALLATION DIAGRAM PFHC泵组安装尺寸表

M=1450rpm																		
Model 型号	[KW] 功率	a	h1	h2	L1	L2	L	A	B	H	HD	m1	m2	n1	n2	S1	S2	重量kg
PFHCM80-400	15	125	280	355	249	297	809	254	254	160	420	160	120	400	315	18	15	303
	18.5	125	280	355	249	310	839	279	241	180	455	160	120	400	315	18	15	337
	22	125	280	355	249	310	879	279	279	180	455	160	120	400	315	18	15	353
	30	125	280	355	249	322	909	318	305	200	505	160	120	400	315	18	19	425
PFHCM100-200	37	125	280	355	284	358	964	356	286	225	560	160	120	400	315	18	19	480
	4	125	200	280	179	189	519	190	140	112	300	160	120	360	280	18	12	130
	5.5	125	200	280	202	231	592	216	140	132	345	160	120	360	280	18	12	145
	7.5	125	200	280	202	231	632	216	178	132	345	160	120	360	280	18	12	158
PFHCM100-250	7.5	140	225	280	206	235	636	216	178	132	345	160	120	400	315	18	12	200
	11	140	225	280	238	286	743	254	210	160	420	160	120	400	315	18	15	243
	15	140	225	280	238	286	798	254	254	160	420	160	120	400	315	18	15	265
	11	140	250	315	235	283	740	254	210	160	420	160	120	400	315	18	15	252
PFHCM100-315	15	140	250	315	235	283	795	254	254	160	420	160	120	400	315	18	15	274
	18.5	140	250	315	235	296	825	279	241	180	455	160	120	400	315	18	15	305
	22	140	250	315	235	296	865	279	279	180	455	160	120	400	315	18	15	324
	30	140	250	315	237	310	897	318	305	200	505	160	120	400	315	18	19	390
PFHCM100-400	18.5	140	250	315	235	296	825	279	241	180	455	160	120	400	315	18	15	350
	22	140	280	355	249	295	879	279	279	180	455	200	150	500	400	23	15	366
	30	140	280	355	249	307	909	318	305	200	505	200	150	500	400	23	19	434
	37	140	280	355	284	358	964	356	286	225	560	200	150	500	400	23	19	488
PFHCM100-500	45	140	280	355	284	358	989	356	311	225	560	200	150	500	400	23	19	515
	45	160	315	400	284	358	989	356	311	225	560	200	150	500	400	23	19	640
	55	160	315	400	284	377	1054	406	349	250	615	200	150	500	400	23	19	750
	75	160	315	400	284	399	1129	457	368	280	680	200	150	500	400	23	24	840
PFHCM125-250	90	160	315	400	284	424	1194	457	419	280	715	200	150	500	400	23	24	895
	11	140	250	355	235	283	740	254	210	160	420	160	120	400	315	18	15	256
	15	140	250	355	238	286	798	254	254	160	420	160	120	400	315	18	15	278
	18.5	140	250	355	238	299	822	279	241	180	455	160	120	400	315	18	15	310
PFHCM125-315	22	140	250	355	238	339	862	279	279	180	455	160	120	400	315	18	15	326
	18.5	140	280	355	249	295	839	279	279	180	455	200	150	500	400	23	15	325
	22	140	280	355	249	295	879	279	241	180	455	200	150	500	400	23	15	338
	30	140	280	355	249	307	909	318	305	200	505	200	150	500	400	23	19	406
PFHCM125-400	37	140	280	355	284	358	964	356	286	225	560	200	150	500	400	23	19	460
	37	160	315	400	284	358	964	356	286	225	560	200	150	500	400	23	19	498
	45	160	315	400	284	358	989	356	311	225	560	200	150	500	400	23	19	525
	55	160	315	400	284	377	1054	406	349	250	615	200	150	500	400	23	24	640
	75	160	315	400	284	399	1129	457	368	280	680	200	150	500	400	23	24	725

HORIZONTAL END SUCTION PUMP

PFHC SERIES / 卧式端吸泵
PFH/PFHC系列

VALVE ELBOW 阀门弯头

Flow Resistance of Elbow Valve & Gate Valve (CM Water Column) 弯头、阀门和闸阀的流动阻力 (CM水柱)														
Flow Rate 流速	Sharp Elbow 锐角弯头					Smooth Elbow 光滑弯头					Standard Gate Valve 标准闸阀	Foot Valve 底阀	Check Valve 止回阀	
	a=30	a=40	a=60	a=80	a=90	=0.4	=0.6	=0.8	=1	1.5				
0.10	0.03	0.04	0.05	0.07	0.08	0.007	0.008	0.01	0.0155	0.027	0.030	30	30	
0.15	0.06	0.07	0.10	0.14	0.17	0.016	0.019	0.024	0.033	0.06	0.033	31	31	
0.2	0.11	0.13	0.18	0.26	0.31	0.028	0.033	0.04	0.058	0.11	0.058	31	31	
0.25	0.17	0.21	0.28	0.4	0.48	0.044	0.052	0.063	0.091	0.17	0.090	31	31	
0.3	0.25	0.30	0.41	0.6	0.7	0.063	0.074	0.09	0.13	0.25	0.13	31	31	
0.35	0.33	0.40	0.54	0.8	0.93	0.085	0.10	0.12	0.18	0.33	0.18	31	31	
0.4	0.43	0.52	0.71	1.0	1.2	0.11	0.13	0.16	0.23	0.43	0.23	32	31	
0.5	0.67	0.81	1.1	1.6	1.9	0.18	0.21	0.26	0.37	0.67	0.37	33	32	
0.6	0.97	1.2	1.6	2.3	2.8	0.25	0.29	0.36	0.52	0.97	0.52	34	32	
0.7	1.35	1.65	2.2	3.2	3.9	0.34	0.40	0.48	0.70	1.35	0.70	35	32	
0.8	1.7	2.1	2.8	4.0	4.8	0.45	0.53	0.64	0.93	1.7	0.95	36	33	
0.9	2.2	2.7	3.6	5.2	6.2	0.57	0.67	0.82	1.18	2.2	1.20	37	34	
1.0	2.7	3.3	4.5	6.4	7.6	0.7	0.82	1.0	1.45	2.7	1.45	38	35	
1.5	6.0	7.3	10	14	17	1.6	1.9	2.3	3.3	6	3.3	47	40	
2.0	11	14	18	26	31	2.8	3.3	4.0	5.8	11	5.8	61	48	
2.5	17	21	28	40	48	4.4	5.2	6.3	9.1	17	9.1	78	58	
3.0	25	30	41	60	70	6.3	7.4	9	13	25	13	100	71	
3.5	33	40	55	78	93	8.5	10	12	18	33	18	123	85	
4.0	43	52	70	100	120	11	13	16	23	42	23	150	100	
4.5	55	67	90	130	160	14	21	26	37	55	37	190	120	
5.0	67	82	110	160	190	18	29	36	52	67	32	220	140	

1.The flow resistance in elbow is caused by the Contraction of flow line what is due to the change of direction.
2.The flow resistance of the value and gate valve are confirmed according to the actual test results.

1.弯头中的流动阻力是由于方向的改变导致流线的收缩引起的。
2.阀门和闸阀的流动阻力值根据实际的测试结果而定。

HORIZONTAL END SUCTION PUMP

PFH/PFHC SERIES / 卧式端吸泵
PFH/PFHC系列

UNIT CONVERSION TABLES 单位换算表

Flow 流量

升每分 (l/min)	立方米每小时 (m ³ /h)	立方英尺每小时 (ft ³ /h)	立方英尺每分钟 (ft ³ /min)	英制加仑每分钟 (Imp.gal./min)	美制加仑每分钟 (US gal./min)
1.0000	0.06600	2.1189	0.0353	0.2200	0.2640
16.6670	1.0000	35.3147	0.5886	3.6660	4.4030
0.4720	0.0283	1.0000	0.0167	0.1040	0.1250
28.3170	1.6990	60.0000	1.0000	6.2290	7.4800
4.5460	0.2728	9.6326	0.1605	1.0000	1.2010
3.7850	0.2271	8.0209	0.1337	0.8330	1.0000
0.1100	0.0066	0.2339	0.0039	0.2040	0.0290

Pressure and water 压力与水

每平方米牛顿 (N/m ²)	千帕 (kpa)	巴 (bar)	英磅平方英寸 (psi)	米水柱 (m H ₂ O)	毫米水银柱 (mm Hg)
1.0000	0.0010	1*10 ⁵	1.45*10 ⁻⁴	1.02*10 ⁻⁴	0.0075
1.000.0000	1.0000	0.0100	0.1450	0.1020	7.5000
100.000.0000	100.0000	1.0000	14.5000	10.2000	750.1000
98.067.0000	98.0700	0.9810	14.2200	10.0000	735.6000
6.895.0000	6.8950	0.0690	1.0000	0.7030	51.7200
2.984.0000	2.9840	0.0300	0.4330	0.3050	22.4200
9.7890000	9.7890	0.0980	1.4200	1.0000	73.4200
133.3000	0.1330	0.0013	0.0190	0.0140	1.0000
3.386.0000	3.3860	0.0338	0.4910	0.3450	25.400090

Length 长度

毫米 (mm)	厘米 (cm)	米 (m)	英寸 (in)	英尺 (ft)	码 (yd)
1.0000	0.1000	0.0010	0.0394	0.0033	0.0011
10.0000	1.0000	0.0100	0.3937	0.0328	0.0109
1000.0000	100.0000	1.0000	39.3701	3.2808	1.0936
25.4000	2.5400	0.0254	1.0000	0.8033	0.0278
304.8000	30.4800	0.3048	12.0000	1.0000	0.3333
914.4000	91.4400	0.9144	36.0000	3.0000	1.0000

Volume 容积

立方米 (m ³)	升 (L)	毫升 (ml)	英制加仑 (imp.gal.)	美制加仑 (US gal)	立方英尺 (ft ³)
1.0000	1.000.0000	1*10	220.0000	264.2000	35.3147
0.0010	1.0000	1.000.0000	0.2200	0.2642	0.0353
1*10	0.0010	1.0000	22*10	2.642*10	3.53*10
0.0045	4.5460	4.546.0000	1.0000	1.2010	0.1605
0.0038	3.7850	3.785.0000	0.8327	1.0000	0.1337
0.0283	28.3170	28.317.0000	6.2288	7.4805	1.000

