



Contact us

| www.u-flo.com

U-FLO PUMPS (HK) CO., LIMITED

ADD: FLAT/RM 1105 LIPPO CENTRE TOWER 1, 89 QUEENSWAY ADMIRALTY HK

VP SERIES CAST SS SUBMERSIBLE PUMP

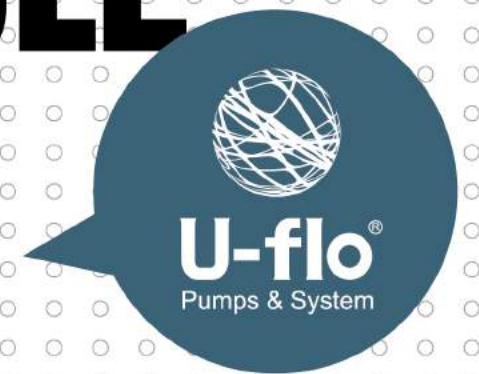

Contents

03/04 **COMPANY PROFILE**

U.S. U-flo

05/40 **PRODUCTS**

CAST STAINLESS STEEL SUBMERSIBLE PUMP VP series

CAST IRON SUBMERSIBLE PUMP LVP series

41/48 **OTHERS**

SUPPORTING DEVICES

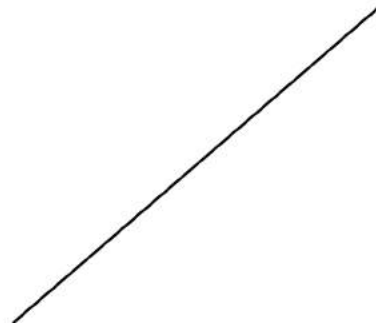
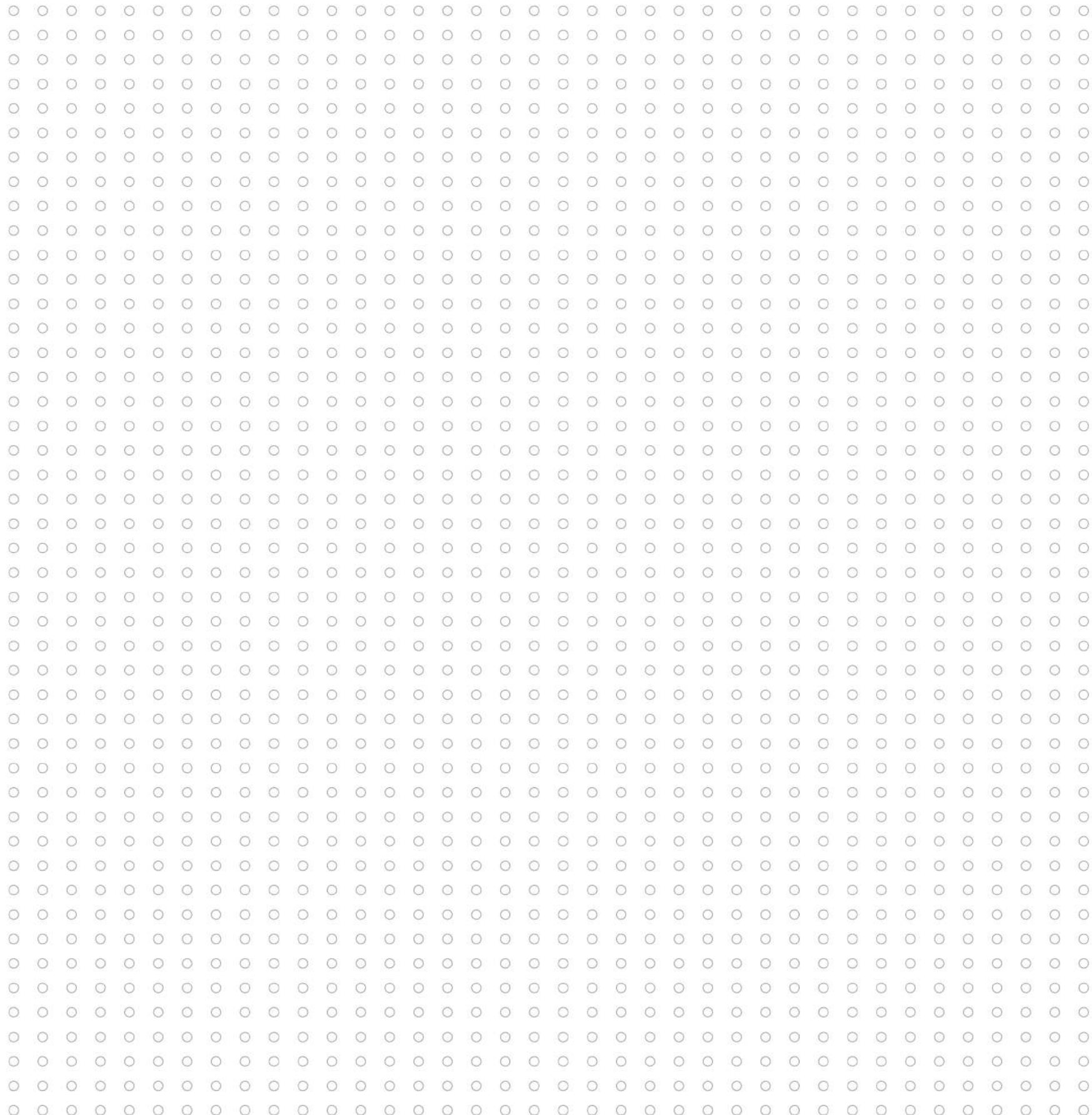



U-flo Pumps International LLC is a global water pump manufacturing and marketing company registered in Washington, USA. Our cooperated facilities are located in Italy, Japan, Taiwan and China. Our primary products include Deep-well Pumps, Above-ground Pumps, Sewage Pumps, Pumping Systems. They are widely used in power plants, paper mills, steel plants, agriculture irrigations, construction trades, industrial applications, mining operations, municipal utilities as well as oil/gas fields.

Integrity, Innovation, International

Since the first U-FLO water pump was manufactured, our people have been making unremitting endeavor to improve designs of the U-FLO water pump products. We apply the best industry practices and the best suitable materials for key components to the design and manufacturing of our pumps.

In addition to our state of art manufacturing facilities, we put a big effort on pump testing. Every product undergoes a rigorous testing and inspection process before being shipped to our customers. Our test facility incorporates a 12000 cubic meter (52,834 gallon) closed loop system with testing capacity of up to 600m³/h (2640GPM) with the maximum head of 200m (656ft), and 250 horsepower (dual voltages of 50Hz and 60Hz). Following a strict quality management system, all of our facilities are ISO 9001 and ISO 4001 certified.

Water is a vital part of our natural resources. While we always pursue the excellence of our products and services, we also take every step to promote environment-friendly and energy-saving solutions.

As a global pump manufacturer and supplier, U-FLO is committed to producing the finest water pumps in the world and continues to lead the way forward in the pumping industry.



Quality witness responsibility Technology create reliability



Design & production

The deep well submersible pump consists of motor, pump body, lifting pipe, pump base etc. After the cable connected to the power supply, the motor starts and drives the motor shaft and impeller. The advantages of the pump are: simple structure, space-saving, lightweight, easy to install, high safety, reliable operation and high efficiency.

Product application scope

U-FLO deep well submersible pump is used to pump the non-solid medium which pH 1-11, sediment concentration less than 350g/m³ and water temperature from 0 to 95 degrees. It's widely used in building water supply, agricultural irrigation, RO reverse osmosis system, mining, marine platforms, landscape design, geothermal hot springs, underground deep well water pumping and other industrial uses.

U-FLO reserves the right to make modifications without notice.



CAST SS SUBMERSIBLE PUMP 4"-8"

CAST SS SUBMERSIBLE PUMP



I、Features

High efficiency: high-efficiency and hydraulic model designed impeller saved operating costs.

Occupied a smaller space: motor and pump are connected vertically, therefore need a less installation space.

Check valve (Optional): the check valve installed at the upper end of the pump body will prevent the pump from water shock when power cuts.

Diversified combination: the pump parts can be flexible assembled according to different flows and heads, which to meet the requirements of different customers.

No pollution: the pump body and motor adopt stainless steel material which is of good anti-corrosive performance and will not cause secondary pollution.

Low noise: as the pump body placed under the water, it will make lower noise.

Provide a wide range of pumps: U-FLO provides a series of stainless steel pumps apply to different voltages (1000V/660V/460V/380V/220V), frequencies (50Hz/60Hz) and Speed (2900RPM/1450RPM)

Flow range: 0.5m³/h-1800m³/h

Head range: 5m-600m

Max. motor frequency: 400kw

Low installation costs: the stainless steel material makes the pump lightweight and easy carried. Meanwhile it can lower assembly cost, save installation and maintenance time.

Bearing with Sand filter channel: the water-lubricating and rectangular-shaped bearing can discharge the existed sand while pump the liquid.

Inlet strainer: the inlet strainer can prevent the particles and big particles which exceed the specified quantity into the pump body.

NEMA standard: all the motor connector dimension of U-FLO submersible pumps meet NEMA standard.

VP

4"

6"

8"

10"

12"

14"

LVP

15/16"

19/22"

24"

OTHERS

CAST SS SUBMERSIBLE PUMP

VP SERIES

II、 MATERIAL SPECIFICATIONS

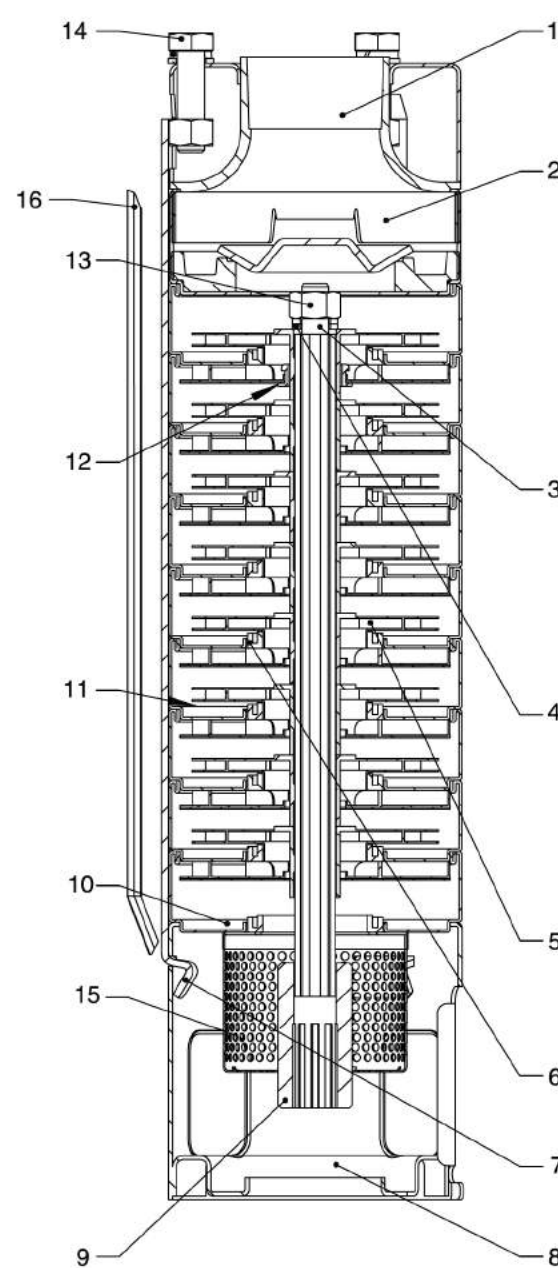

PART NAME	VP	VPN
1 Outlet	304SS	316SS
2 Check valve (Optional)	304SS	316SS
3 Pump shaft	304SS	316SS
4 Washer	304SS	316SS
5 Impeller	304SS	316SS
6 Liner ring	NBR	HNBR
7 Fixed strip	304SS	316SS
8 Suction connection	304SS	316SS
9 Coupling	304SS	316SS
10 Suction casing	304SS	316SS
11 Pump casing	304SS	316SS
12 Rubber bearings	NBR	HNBR
13 Impeller locknut	304SS	316SS
14 Fixed plate bolts	304SS	316SS
15 Suction strainer	304SS	316SS
16 Grommet	304SS	316SS

Note: 4" - 8" check valves are optional

CAST SS SUBMERSIBLE PUMP

VP SERIES

II、 MATERIAL SPECIFICATIONS

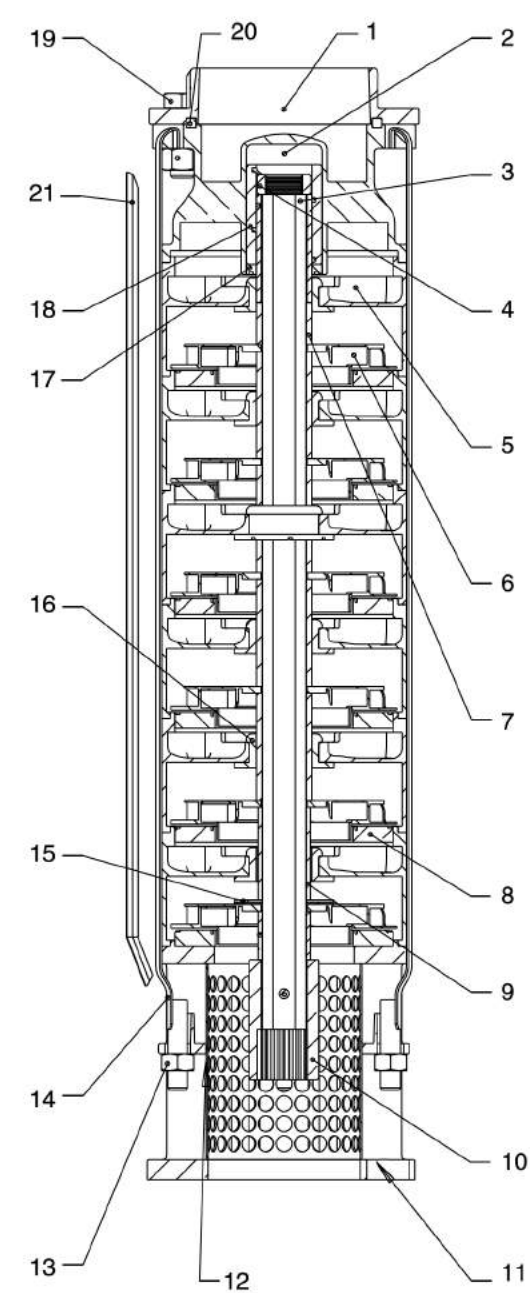

PART NAME	VP	VPN
1 Outlet	304SS	316SS
2 Copper exports Block	304SS	316SS
3 Pump shaft	304SS	316SS
4 Impeller locknut	Bronze	Bronze
5 Pump casing	304SS	316SS
6 Impeller	304SS	316SS
7 Upper sleeve	304SS	316SS
8 Liner ring	NBR	HNBR
9 Middle sleeve	304SS	316SS
10 Coupling	304SS	316SS
11 Suction connection	304SS	316SS
12 Suction strainer	304SS	316SS
13 Fixed plate bolts	304SS	316SS
14 Fixed strip	304SS	316SS
15 Anti-floating pads	304SS	316SS
16 Rubber bearings	NBR	HNBR
17 Seal	NBR	HNBR
18 Copper bearing	Bronze	Bronze
19 Outlet bolts	304SS	316SS
20 Seals	NBR	HNBR
21 Grommet	304SS	316SS

Note: 4" - 8" check valves are optional

VP

4"

6"

8"

10"

12"

14"

LVP

15/16"

19/22"

24"

OTHERS

CAST SS SUBMERSIBLE PUMP

VP SERIES

III 、 PRODUCT MATERIAL DESCRIPTION

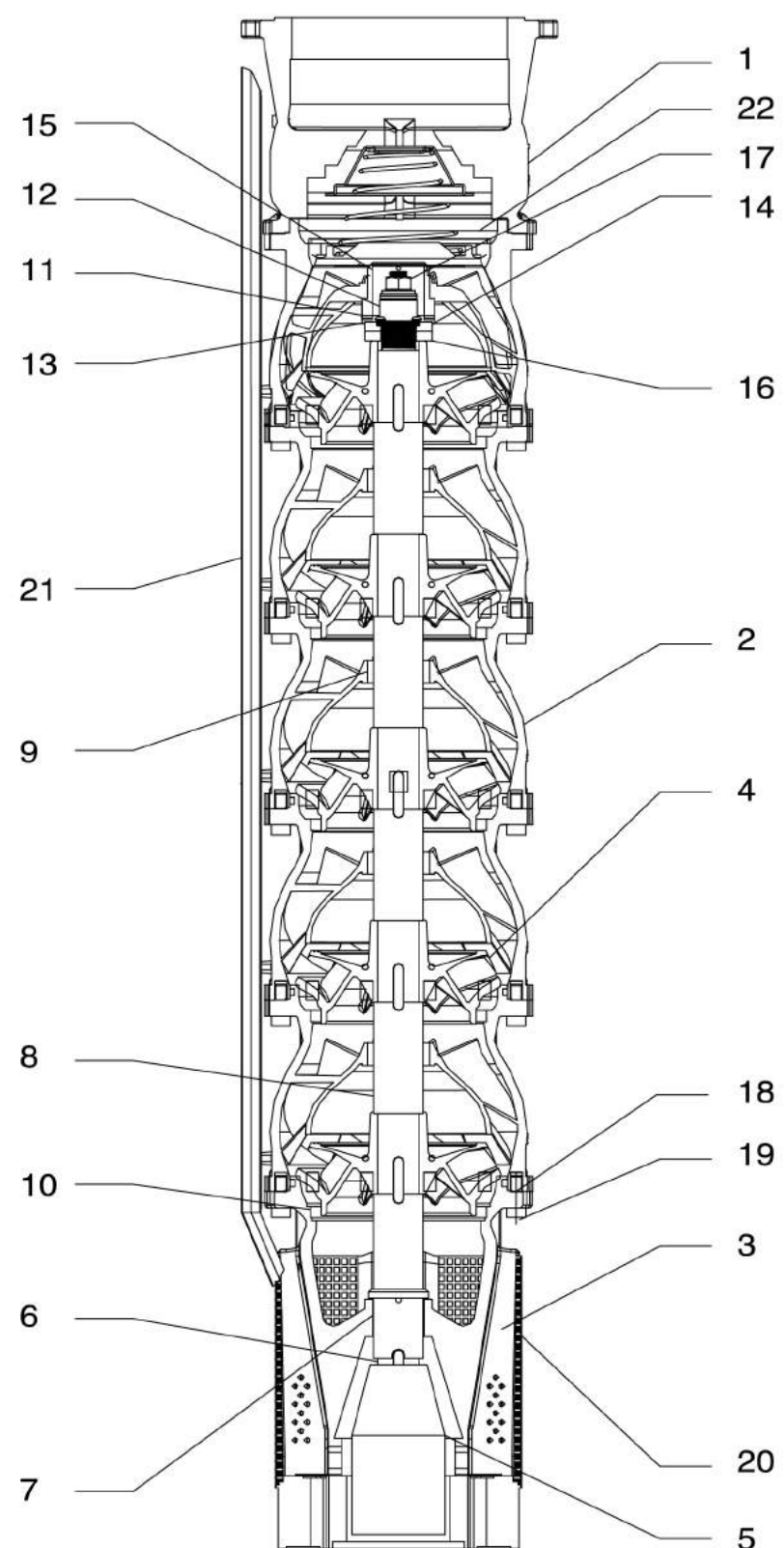

CAST SS SUBMERSIBLE PUMP

VP SERIES

PART NAME	VP	VPN	VPD
1 Discharge casing	304SS	316SS	Duplex stainless steel
2 Intermediate casing	304SS	316SS	Duplex stainless steel
3 Suction casing	304SS	316SS	Duplex stainless steel
4 Impeller	304SS	316SS	Duplex stainless steel
5 Coupling	304SS	316SS/329SS	Duplex stainless steel
6 Pump shaft	304SS	630SS	Duplex stainless steel
7 Lower sleeve	304SS	316SS	Duplex stainless steel
8 Intermediate sleeve	304S.S	316SS	Duplex stainless steel
9 Intermediate bearing	NBR	316SS/HNBR	Duplex stainless steel
10 Sealing ring	NBR	316SS/HNBR	Duplex stainless steel
11 Upper shell bearing	Silicon carbide	Silicon carbide	Silicon carbide
12 Bearing sleeve	Silicon carbide	Silicon carbide	Silicon carbide
13 Up-thrust Disc	304SS	316SS	Duplex stainless steel
14 Up-thrust washer	PTFE	PTFE	PTFE
15 Sleeve	304SS	316SS	Duplex stainless steel
16 Impeller locknut	304SS	316SS	Duplex stainless steel
17 Shaft nut	304SS	316SS	Duplex stainless steel
18 O-ring	NBR	HNBR	HNBR
19 Bolt/Nut	304SS	316SS	Duplex stainless steel
20 Suction strainer	304SS	316SS	Duplex stainless steel
21 Cable guard	304SS	316SS	Duplex stainless steel / EPDM
22 Check valve	304SS	316SS/EPDM	Duplex stainless steel

MODEL DESCRIPTION

VP – CAST 304 STAINLESS STEEL SUBMERSIBLE PUMP

VPC – CAST IRON SUBMERSIBLE PUMP

(OPTIONAL IMPELLER MATERIALS: CAST IRON, BRONZE, STAINLESS STEEL)

VPN – CAST 316 STAINLESS STEEL SUBMERSIBLE PUMP

VPD – CAST DUPLEX STAINLESS STEEL SUBMERSIBLE PUMP

FVP – ALL STAINLESS STEEL FOUNTAIN PUMP

SVP – ALL STAINLESS STEEL SAFE-NIOSE PUMP

HVP – HIGH TEMPERATURE SUBMERSIBLE PUMP

LVP – LARGE CAPACITY SUBMERSIBLE PUMP (50HZ/1450RPM)

VP

4"

6"

8"

10"

12"

14"

LVP

15/16"

19/22"

24"

OTHERS

CAST SS SUBMERSIBLE PUMP

VP SERIES

IV、PERFORMANCE CURVE CHART

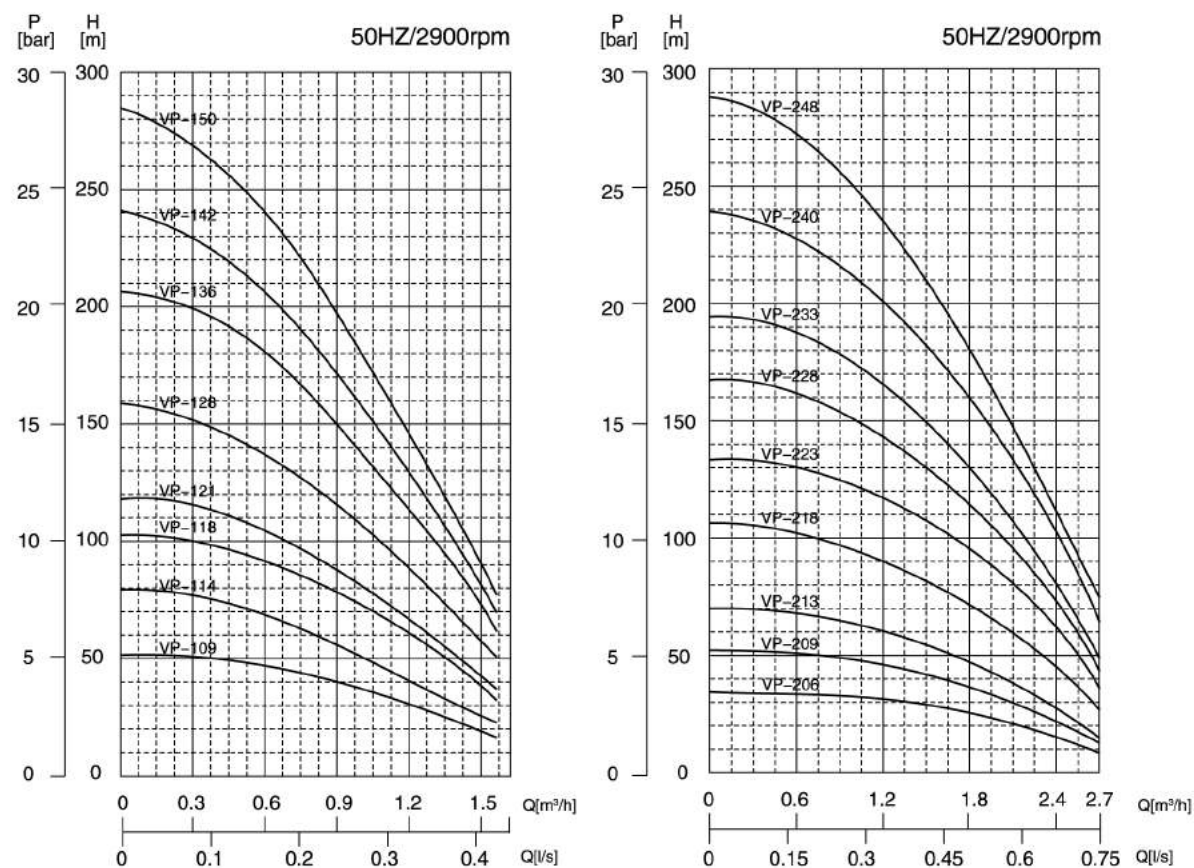

BASIC PARAMETERS

Model	Stage Number	Power		Length		Weight		Outlet Dia. DN		Pump		Total Length [mm]
		[KW]	[HP]	[mm]	[kg]	[mm]	[kg]	[mm]	[kg]	[mm]	[mm]	
VP-109	9	0.37	0.5	236	6.7	1" 1/4	354	3	590			
VP-114	14	0.37	0.5	236	6.7	1" 1/4	459	4	695			
VP-118	18	0.55	0.75	266	8	1" 1/4	543	2	809			
VP-121	21	0.55	0.75	266	8	1" 1/4	606	5	872			
VP-128	28	0.75	1	286	9	1" 1/4	753	7	1039			
VP-136	36	1.1	1.5	331	11	1" 1/4	946	9	1277			
VP-142	42	1.1	1.5	331	11	1" 1/4	1072	10	1403			
VP-150	50	1.5	2	393	13	1" 1/4	1240	11	1633			
VP-206	6	0.37	0.5	236	6.7	1" 1/4	291	3	527			
VP-209	9	0.37	0.5	236	6.7	1" 1/4	354	3	590			
VP-213	13	0.55	0.75	266	8	1" 1/4	438	4	704			
VP-218	18	0.75	1	286	9	1" 1/4	543	5	829			
VP-223	23	1.1	1.5	331	11	1" 1/4	658	6	989			
VP-228	28	1.5	2	393	13	1" 1/4	753	7	1146			
VP-233	33	1.5	2	393	13	1" 1/4	858	8	1251			
VP-240	40	2.2	3	413	13.8	1" 1/4	1030	10	1443			
VP-248	48	2.2	3	413	13.8	1" 1/4	1198	12	1611			



CAST SS SUBMERSIBLE PUMP

VP SERIES

IV、PERFORMANCE CURVE CHART

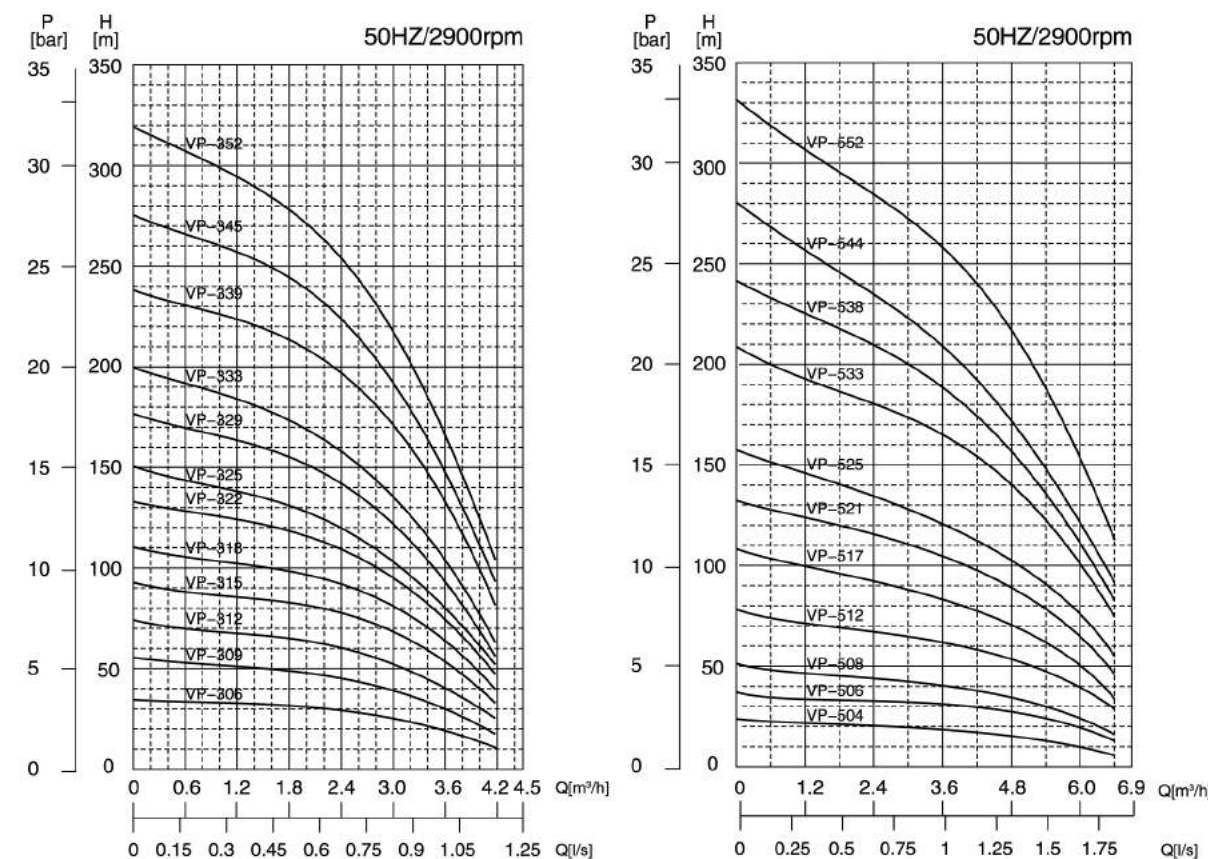

BASIC PARAMETERS

Model	Stage Number	Power		Motor		Pump			Total Length [mm]
		[KW]	[HP]	Length [mm]	Weight [kg]	Outlet Dia. DN [inch]	Length L [mm]	Weight [kg]	
VP-306	6	0.37	0.5	236	6.7	1" 1/4	291	3	527
VP-309	9	0.55	0.75	266	8	1" 1/4	354	3	620
VP-312	12	0.75	1	286	9	1" 1/4	417	4	703
VP-315	15	1.1	1.5	331	11	1" 1/4	480	4	811
VP-318	18	1.1	1.5	331	11	1" 1/4	543	5	874
VP-322	22	1.5	2	393	13	1" 1/4	627	6	1020
VP-325	25	1.5	2	393	13	1" 1/4	690	6	1083
VP-329	29	2.2	3	413	13.8	1" 1/4	774	7	1187
VP-333	33	2.2	3	413	13.8	1" 1/4	858	8	1271
VP-339	39	3	4	544	19.7	1" 1/4	1009	10	1553
VP-345	45	3	4	544	19.7	1" 1/4	1135	11	1679
VP-352	52	4	5.5	614	23	1" 1/4	1282	13	1896
VP-504	4	0.37	0.5	236	6.7	1" 1/2	249	2	485
VP-506	6	0.55	0.75	266	8	1" 1/2	291	3	557
VP-508	8	0.75	1	286	9	1" 1/2	333	3	619
VP-512	12	1.1	1.5	331	11	1" 1/2	417	4	748
VP-517	17	1.5	2	393	13	1" 1/2	522	5	915
VP-521	21	2.2	3	413	13.8	1" 1/2	606	6	1019
VP-525	25	2.2	3	413	13.8	1" 1/2	690	6	1103
VP-533	33	3	4	544	19.7	1" 1/2	858	8	1402
VP-538	38	4	5.5	614	23	1" 1/2	988	10	1602
VP-544	44	4	5.5	614	23	1" 1/2	1114	11	1728
VP-552	52	5.5	7.5	684	26.6	1" 1/2	1282	13	1966



VP

4"

6"

8"

10"

12"

14"

LVP

15/16"

19/22"

24"

OTHERS

CAST SS SUBMERSIBLE PUMP

VP SERIES

IV、PERFORMANCE CURVE CHART

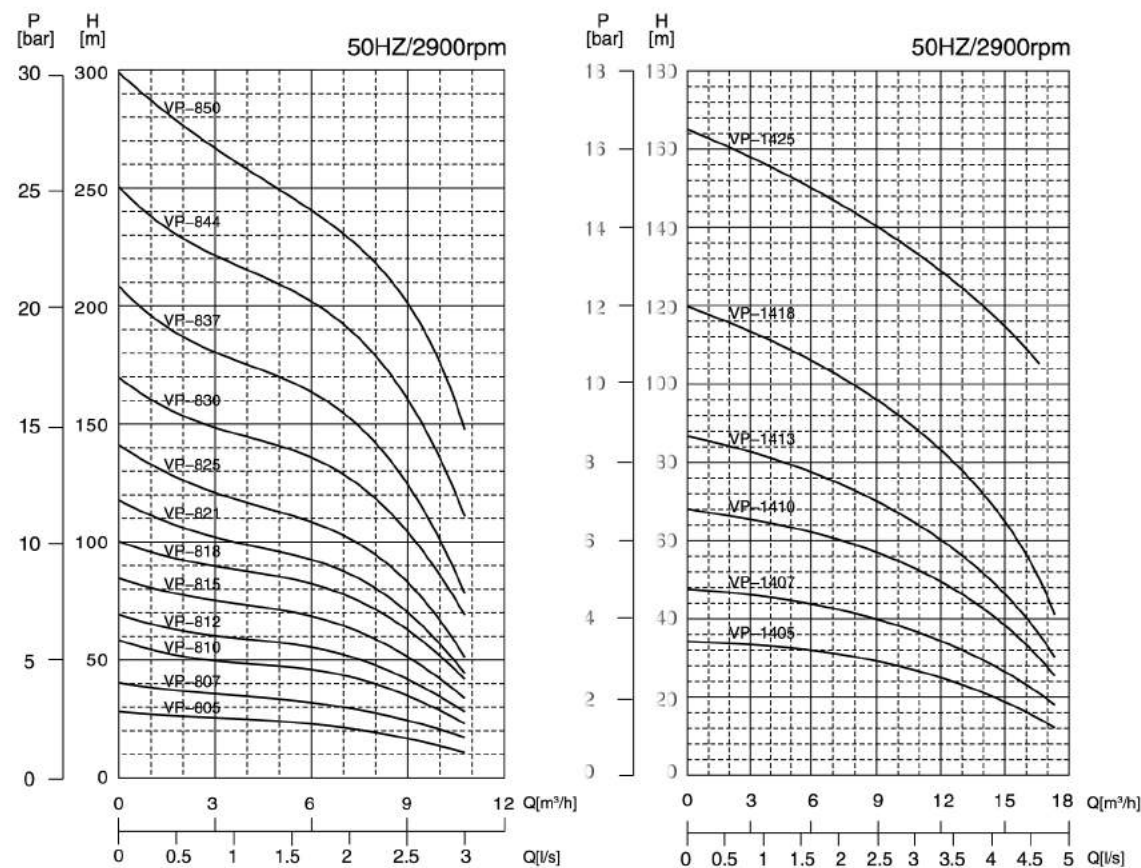

BASIC PARAMETERS									
Model	Stage Number	Motor 电机		Pump 水泵					
		Power [KW]	Power [HP]	Length [mm]	Weight [kg]	Outlet Dia. DN [inch]	Length L [mm]	Weight [kg]	Total Length [mm]
VP-805	5	0.75	1	286	9	2"	411	5	697
VP-807	7	1.1	1.5	331	11	2"	495	5	826
VP-810	10	1.5	2	393	13	2"	621	7	1014
VP-812	12	2.2	3	413	13.8	2"	705	8	1118
VP-815	15	2.2	3	413	13.8	2"	831	9	1244
VP-818	18	3	4	544	19.7	2"	957	11	1501
VP-821	21	4	5.5	614	23	2"	1083	12	1697
VP-825	25	4	5.5	614	23	2"	1251	14	1865
VP-830	30	5.5	7.5	684	26.6	2"	1461	17	2145
VP-837	37	5.5	7.5	684	26.6	2"	1755	20	2439
VP-844	44	7.5	10	764	30.6	2"	2049	36	2813
VP-850	50	7.5	10	764	30.6	2"	2298	53	3062
VP-1405	5	1.5	2	393	13	2"	503	5	896
VP-1407	7	2.2	3	413	13.8	2"	633	6	1046
VP-1410	10	3.7	5	608	23	2"	828	7	1436
VP-1413	13	3.7	5	608	23	2"	1023	9	1631
VP-1418	18	5.5	7.5	684	26.6	2"	1348	11	2032
VP-1425	25	7.5	10	764	30.6	2"	1803	15	2567



CAST SS SUBMERSIBLE PUMP

VP SERIES

IV、PERFORMANCE CURVE CHART

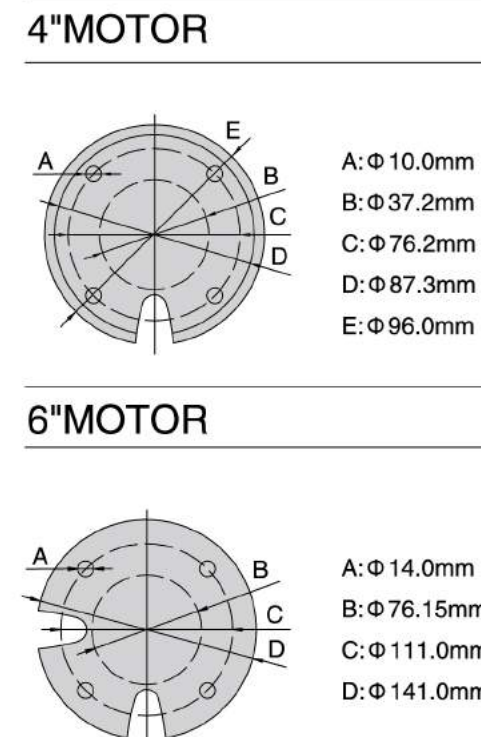
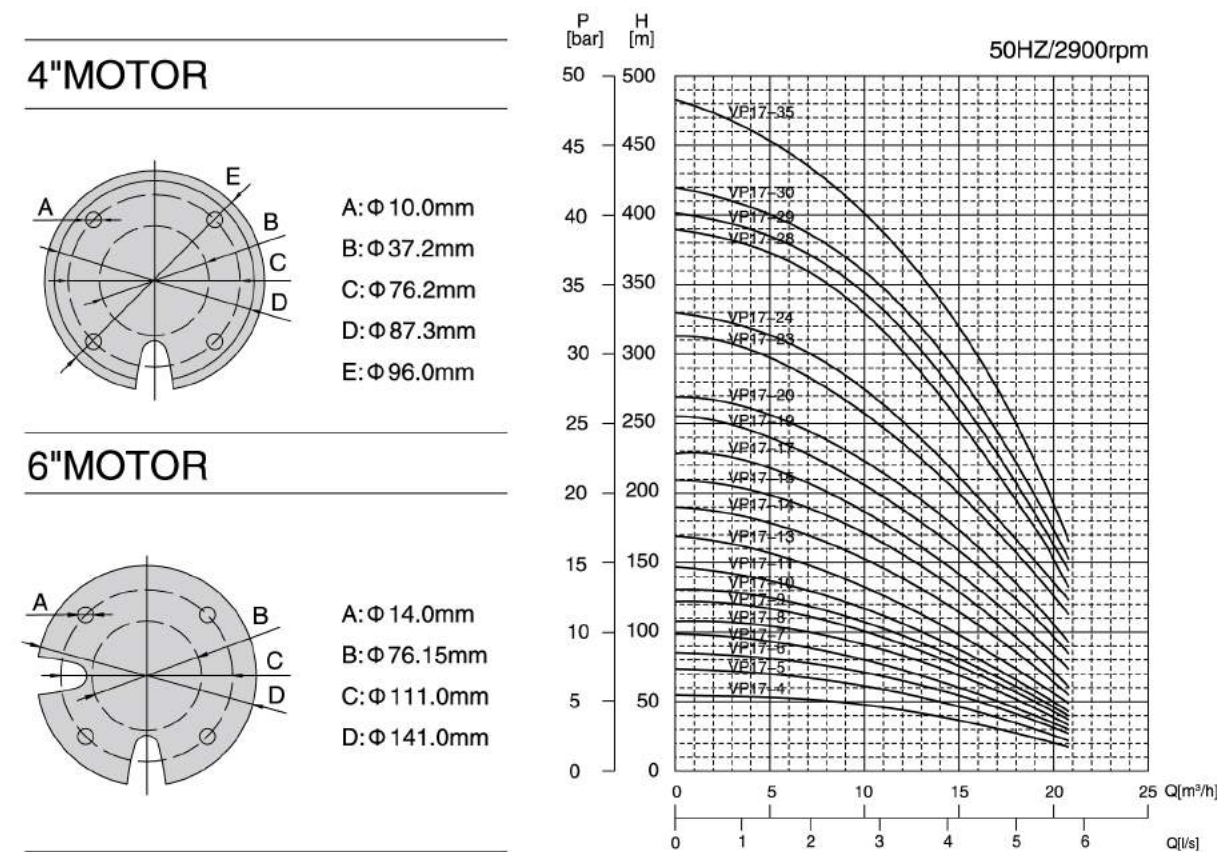

BASIC PARAMETERS										
Model	Stage Number	Motor 电机			Pump 水泵					
		Power [KW]	Power [HP]	Length [mm]	Weight [kg]	Outlet Dia. DN [inch]	Length L [mm]	Weight [kg]	Total Length [mm]	
VP17-4	4	3	4	544	19.7	2"	127	424	12	968
VP17-5	5	3	4	544	19.7	2"	127	472	14	1016
VP17-6	6	3.7	5	608	23	2"	127	564	15	1172
VP17-7	7	5.5	7.5	684	26.6	2"	127	567	17	1251
VP17-8	8	5.5	7.5	684	26.6	2"	127	614	19	1298
VP17-9	9	5.5	7.5	684	26.6	2"	127	662	20	1346
VP17-11	11	7.5	10	764	30.6	2"	127	757	23	1521
VP17-13	13	7.5	10	764	30.6	2"	127	843	27	1607
VP17-14	14	7.5	10	764	30.6	2"	127	890	28	1654
VP17-6	6	3.7	5	600	39.5	2"	127	510	15	1110
VP17-8	8	5.5	7.5	631	43.2	2"	127	605	19	1236
VP17-9	9	5.5	7.5	631	43.2	2"	127	653	20	1284
VP17-10	10	5.5	7.5	631	43.2	2"	127	709	22	1340
VP17-11	11	7.5	10	660	45.5	2"	127	757	23	1417
VP17-13	13	7.5	10	660	45.5	2"	127	843	27	1503
VP17-14	14	7.5	10	660	45.5	2"	127	890	28	1550
VP17-15	15	11	15	730	53	2"	127	938	30	1668
VP17-17	17	11	15	730	53	2"	127	1033	33	1763
VP17-19	19	11	15	730	53	2"	127	1128	36	1858
VP17-20	20	11	15	730	53	2"	127	1175	38	1905
VP17-23	23	15	20	785	59	2"	127	1318	43	2103
VP17-24	24	15	20	785	59	2"	127	1365	45	2150
VP17-28	28	18.5	25	860	66.5	2"	127	1555	50	2415
VP17-29	29	18.5	25	860	66.5	2"	127	1603	52	2463
VP17-30	30	18.5	25	860	66.5	2"	127	1650	54	2510
VP17-35	35	22	30	920	72.5	2"	127	1888	62	2808



CAST SS SUBMERSIBLE PUMP

VP SERIES

IV、 PERFORMANCE CURVE CHART

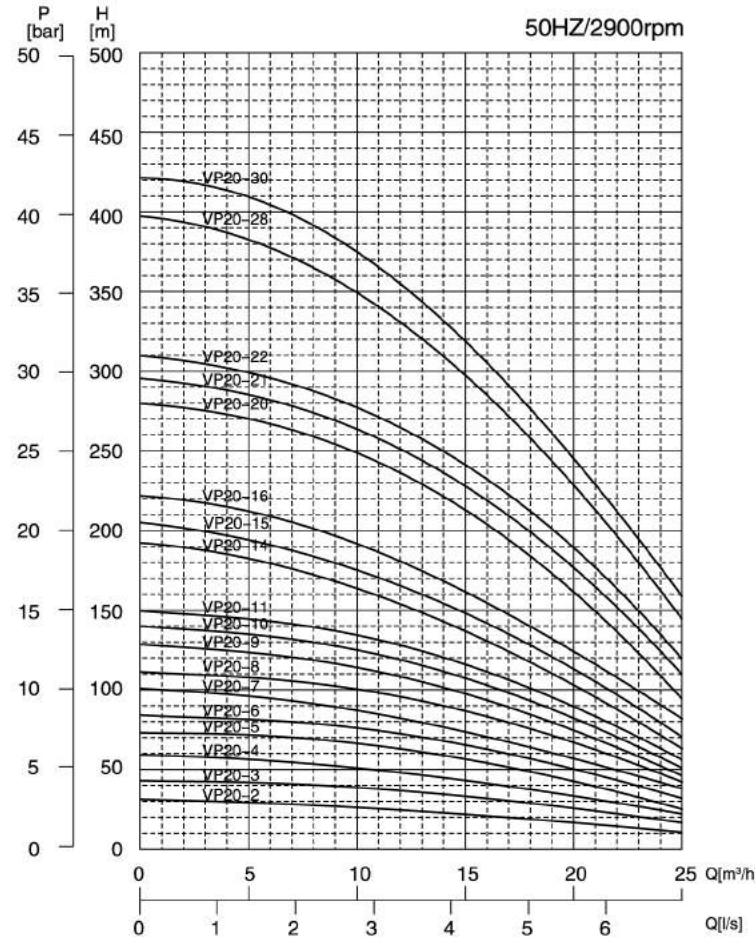

4" MOTOR

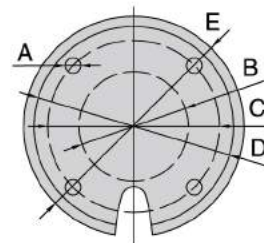

- A: Φ 10.0mm
- B: Φ 37.2mm
- C: Φ 76.2mm
- D: Φ 87.3mm
- E: Φ 96.0mm

6" MOTOR

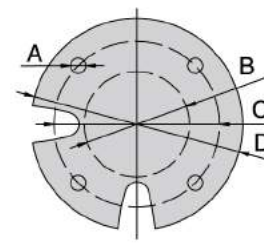

- A: Φ 14.0mm
- B: Φ 76.15mm
- C: Φ 111.0mm
- D: Φ 141.0mm

BASIC PARAMETERS

Model	Stage Number	Power		Motor		Outlet Dia. DN	Pump			
		[KW]	[HP]	[mm]	[kg]		L1	Length L	Weight	Total Length
VP20-2	2	1.5	2	393	13	2"	127	329	9	722
VP20-3	3	2.2	3	413	13.8	2"	127	377	11	790
VP20-4	4	3	4	544	19.7	2"	127	424	12	968
VP20-5	5	3.7	5	608	23	2"	127	472	14	1080
VP20-6	6	3.7	5	608	23	2"	127	519	15	1127
VP20-7	7	5.5	7.5	684	26.6	2"	127	567	17	1251
VP20-8	8	5.5	7.5	684	26.6	2"	127	614	19	1298
VP20-10	10	7.5	10	764	30.6	2"	127	709	22	1473
VP20-11	11	7.5	10	764	30.6	2"	127	748	23	1512
VP20-5	5	3.7	5	600	39.5	2"	127	463	14	1063
VP20-6	6	3.7	5	600	39.5	2"	127	510	15	1110
VP20-8	8	5.5	7.5	631	43.2	2"	127	605	19	1236
VP20-9	9	5.5	7.5	631	43.2	2"	127	662	20	1293
VP20-10	10	7.5	10	660	45.5	2"	127	709	22	1369
VP20-11	11	7.5	10	660	45.5	2"	127	748	23	1408
VP20-14	14	11	15	730	53	2"	127	890	28	1620
VP20-15	15	11	15	730	53	2"	127	938	30	1668
VP20-16	16	11	15	730	53	2"	127	985	31	1715
VP20-20	20	15	20	785	59	2"	127	1175	38	1960
VP20-21	21	15	20	785	59	2"	127	1223	39	2008
VP20-22	22	15	20	785	59	2"	127	1270	41	2055
VP20-28	28	22	30	920	72.5	2"	127	1555	51	2475
VP20-30	30	22	30	920	72.5	2"	127	1650	54	2570



CAST SS SUBMERSIBLE PUMP

VP SERIES

IV、 PERFORMANCE CURVE CHART

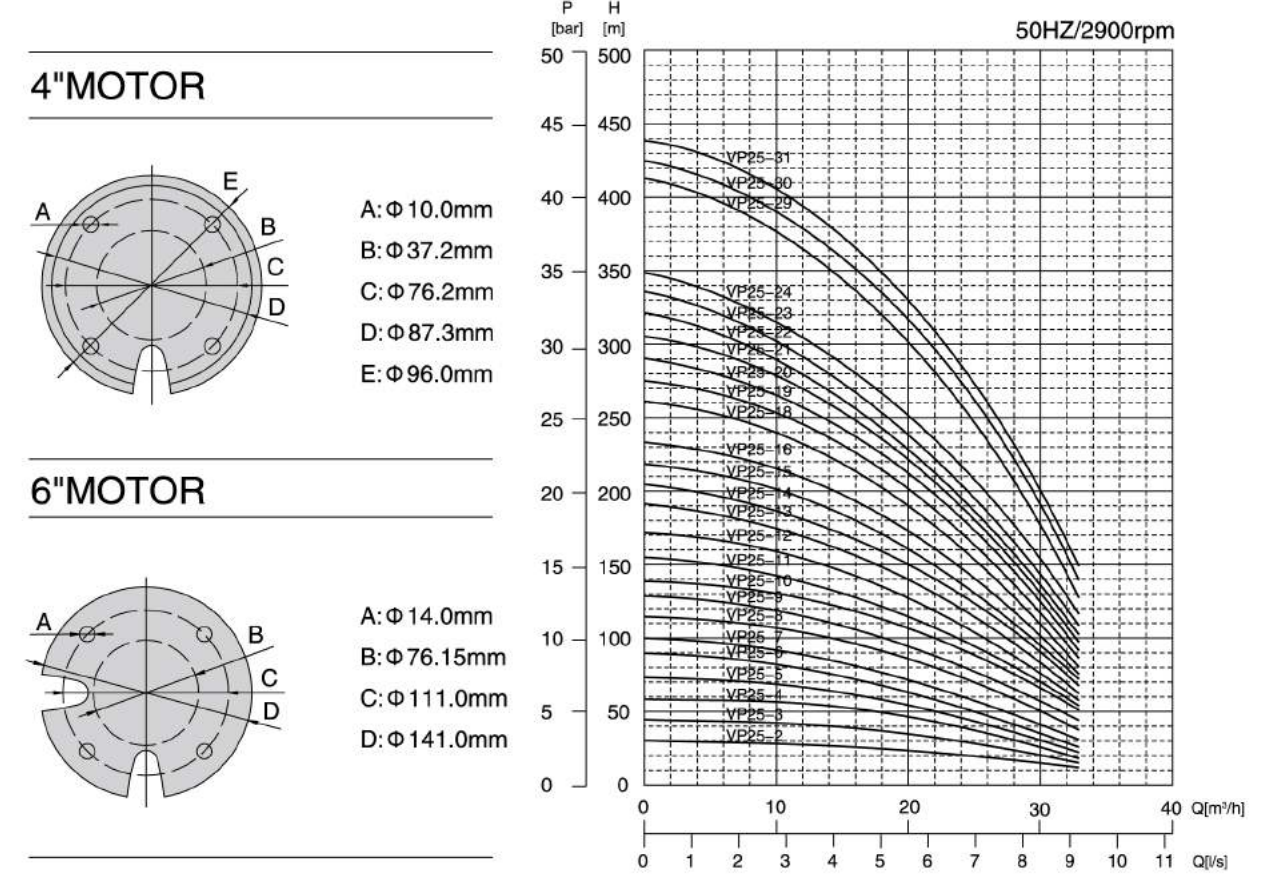

4" MOTOR

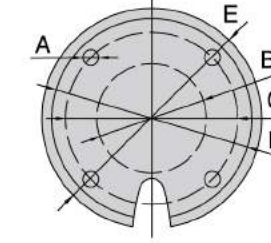

- A: Φ 10.0mm
- B: Φ 37.2mm
- C: Φ 76.2mm
- D: Φ 87.3mm
- E: Φ 96.0mm

6" MOTOR

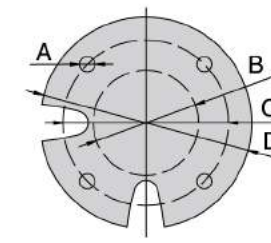

- A: Φ 14.0mm
- B: Φ 76.15mm
- C: Φ 111.0mm
- D: Φ 141.0mm

BASIC PARAMETERS

Model	Stage Number	Motor				Pump				
		Power [KW]	Power [HP]	Length [mm]	Weight [kg]	Outlet Dia. DN	L1 [mm]	Length L [mm]	Weight [kg]	Total Length [mm]
VP25-2	2	2.2	3	413	13.8	2"	127	348	9	761
VP25-3	3	3	4	544	19.7	2"	127	405	11	949
VP25-4	4	3.7	5	608	23	2"	127	462	13	1070
VP25-5	5	5.5	7.5	684	26.6	2"	127	519	14	1203
VP25-6	6	5.5	7.5	684	26.6	2"	127	576	16	1260
VP25-7	7	7.5	10	764	30.6	2"	127	624	18	1388
VP25-8	8	7.5	10	764	30.6	2"	127	681	19	1445
VP25-4	4	3.7	5	600	39.5	2"	127	453	13	1053
VP25-5	5	5.5	7.5	631	43.2	2"	127	510	14	1141
VP25-6	6	5.5	7.5	631	43.2	2"	127	567	16	1198
VP25-7	7	7.5	10	660	45.5	2"	127	624	18	1284
VP25-8	8	7.5	10	660	45.5	2"	127	681	19	1341
VP25-9	9	11	15	730	53	2"	127	738	21	1468
VP25-10	10	11	15	730	53	2"	127	795	23	1525
VP25-11	11	11	15	730	53	2"	127	852	24	1582
VP25-12	12	15	20	785	59	2"	127	909	26	1694
VP25-13	13	15	20	785	59	2"	127	966	28	1751
VP25-14	14	15	20	785	59	2"	127	1023	30	1808
VP25-15	15	15	20	785	59	2"	127	1080	31	1865
VP25-16	16	15	20	785	59	2"	127	1137	33	1922
VP25-18	18	18.5	25	860	66.5	2"	127	1251	37	2111
VP25-19	19	18.5	25	860	66.5	2"	127	1308	38	2168
VP25-20	20	18.5	25	860	66.5	2"	127	1365	40	2225
VP25-21	21	22	30	920	72.5	2"	127	1422	42	2342
VP25-22	22	22	30	920	72.5	2"	127	1479	43	2399
VP25-23	23	22	30	920	72.5	2"	127	1536	45	2456
VP25-24	24	22	30	920	72.5	2"	127	1593	47	2513
VP25-29	29	30	40	1050	85	2"	127	1878	55	2928
VP25-30	30	30	40	1050	85	2"	127	1935	57	2985
VP25-31	31	30	40	1050	85	2"	127	1992	58	3042



CAST SS SUBMERSIBLE PUMP

VP SERIES

IV、PERFORMANCE CURVE CHART

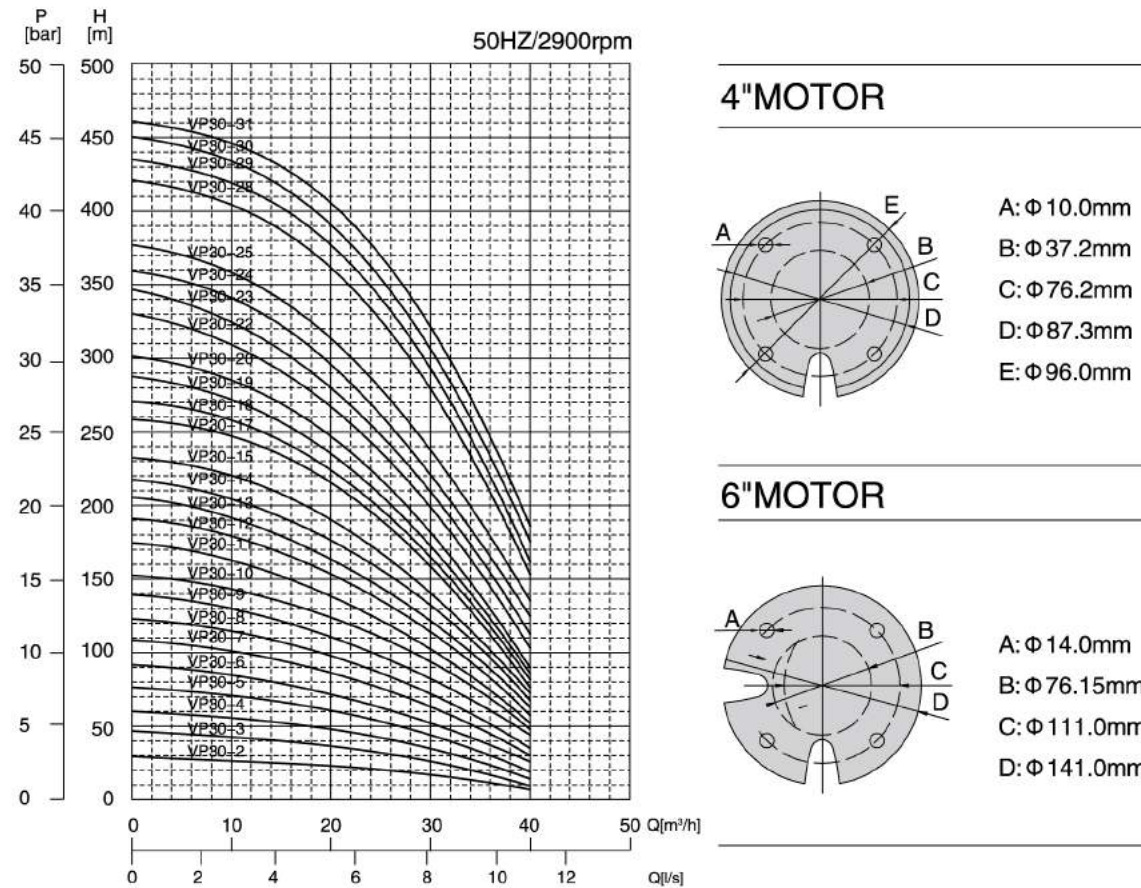

BASIC PARAMETERS										
Model	Stage Number	Power		Length		Weight		Pump		
		[KW]	[HP]	[mm]	[kg]	[mm]	[kg]	Outlet Dia. DN	L1	Length L
4D										
VP30-2	2	2.2	3	413	13.8	3"	127	348	9	761
VP30-3	3	3.7	5	608	23	3"	127	405	11	1013
VP30-4	4	5.5	7.5	684	26.6	3"	127	462	13	1146
VP30-5	5	7.5	10	764	30.6	3"	127	510	14	1274
VP30-6	6	7.5	10	764	30.6	3"	127	567	16	1331
VP30-3	3	3.7	5	600	39.5	3"	127	396	11	996
VP30-4	4	5.5	7.5	631	43.2	3"	127	453	13	1084
VP30-5	5	7.5	10	660	45.5	3"	127	510	14	1170
VP30-6	6	7.5	10	660	45.5	3"	127	567	16	1227
VP30-7	7	11	15	730	53	3"	127	624	18	1354
VP30-8	8	11	15	730	53	3"	127	681	19	1411
VP30-9	9	11	15	730	53	3"	127	738	21	1468
VP30-10	10	11	15	730	53	3"	127	795	23	1525
VP30-11	11	15	20	785	59	3"	127	852	25	1637
VP30-12	12	15	20	785	59	3"	127	909	26	1694
VP30-13	13	15	20	785	59	3"	127	966	28	1751
VP30-14	14	18.5	25	860	66.5	3"	127	1023	30	1883
VP30-15	15	18.5	25	860	66.5	3"	127	1080	31	1940
VP30-17	17	22	30	920	72.5	3"	127	1194	35	2114
VP30-18	18	22	30	920	72.5	3"	127	1251	36	2171
VP30-19	19	22	30	920	72.5	3"	127	1308	38	2228
VP30-20	20	22	30	920	72.5	3"	127	1365	40	2285
VP30-22	22	30	40	1050	85	3"	127	1479	43	2529
VP30-23	23	30	40	1050	85	3"	127	1536	45	2586
VP30-24	24	30	40	1050	85	3"	127	1593	47	2643
VP30-25	25	30	40	1050	85	3"	127	1650	48	2700
VP30-28	28	37	50	1180	98	3"	127	1821	54	3001
VP30-29	29	37	50	1180	98	3"	127	1878	55	3058
VP30-30	30	37	50	1180	98	3"	127	1935	57	3115
VP30-31	31	37	50	1180	98	3"	127	1992	59	3172
6D										



CAST SS SUBMERSIBLE PUMP

VP SERIES

IV、PERFORMANCE CURVE CHART

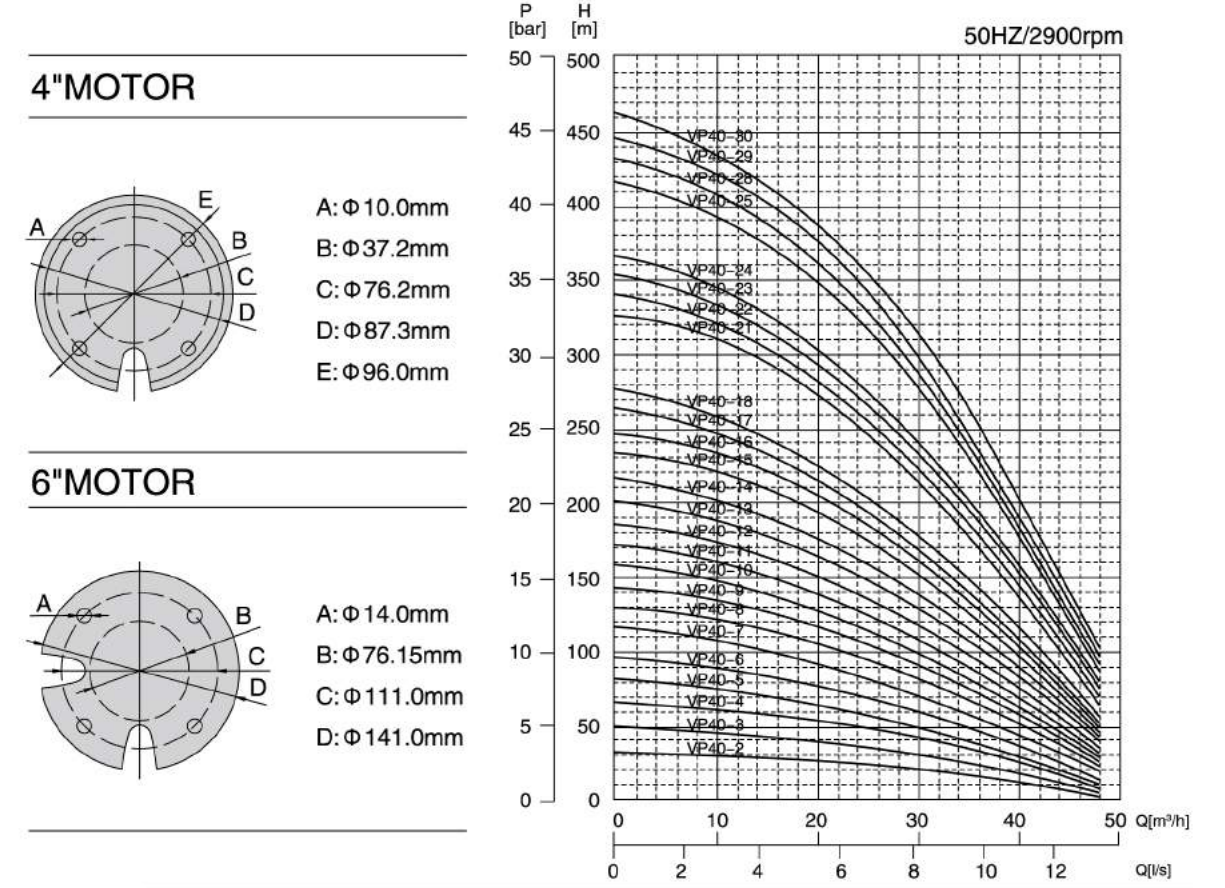

BASIC PARAMETERS										
Model	Stage Number	Power		Length		Weight		Pump		
		[KW]	[HP]	[mm]	[kg]	[mm]	[kg]	Outlet Dia. DN	L1	Length L
4D										
VP40-2	2	3	4	544	19.7	3"	127	348	9	892
VP40-3	3	3.7	5	608	23	3"	127	405	11	1013
VP40-4	4	5.5	7.5	684	26.6	3"	127	462	13	1146
VP40-5	5	7.5	10	764	30.6	3"	127	510	15	1274
VP40-6	6	7.5	10	764	30.6	3"	127	567	17	1331
VP40-3	3	3.7	5	600	39.5	3"	127	396	11	996
VP40-4	4	5.5	7.5	631	43.2	3"	127	453	13	1084
VP40-5	5	7.5	10	660	45.5	3"	127	510	15	1170
VP40-6	6	7.5	10	660	45.5	3"	127	567	17	1227
VP40-7	7	11	15	730	53	3"	127	624	19	1354
VP40-8	8	11	15	730	53	3"	127	681	20	1411
VP40-9	9	11	15	730	53	3"	127	738	22	1468
VP40-10	10	11	15	730	53	3"	127	795	24	1525
VP40-11	11	15	20	785	59	3"	127	852	26	1637
VP40-12	12	15	20	785	59	3"	127	909	28	1694
VP40-13	13	15	20	785	59	3"	127	966	29	1751
VP40-14	14	18.5	25	860	66.5	3"	127	1023	31	1883
VP40-15	15	18.5	25	860	66.5	3"	127	1080	33	1940
VP40-16	16	18.5	25	860	66.5	3"	127	1137	35	1997
VP40-17	17	22	30	920	72.5	3"	127	1194	36	2114
VP40-18	18	22	30	920	72.5	3"	127	1251	38	2171
VP40-21	21	22	30	920	72.5	3"	127	1422	44	2342
VP40-22	22	30	40	1050	85	3"	127	1479	46	2529
VP40-23	23	30	40	1050	85	3"	127	1536	47	2586
VP40-24	24	30	40	1050	85	3"	127	1593	49	2643
VP40-27	27	37	50	1180	98	3"	127	1746	56	2926
VP40-28	28	37	50	1180	98	3"	127	1821	57	3001
VP40-29	29	37	50	1180	98	3"	127	1878	59	3058
VP40-30	30	37	50	1180	98	3"	127	1935	61	3115
6D										



CAST SS SUBMERSIBLE PUMP

VP SERIES

IV、PERFORMANCE CURVE CHART

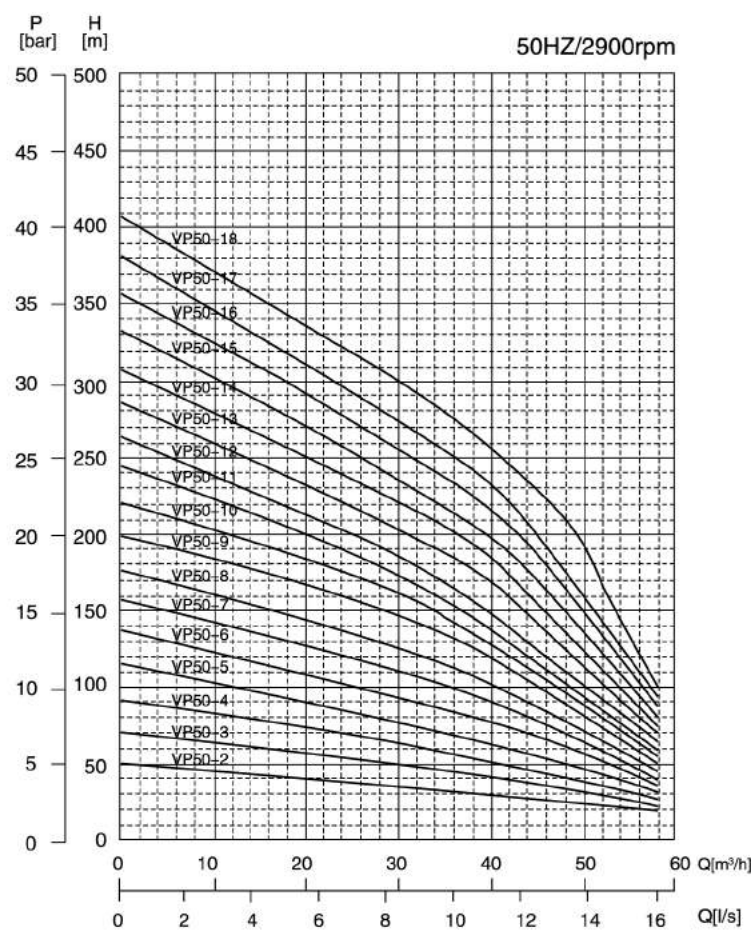

6" MOTOR

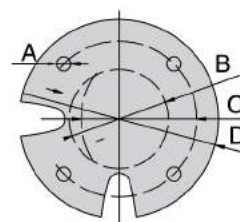

- A: Φ 14.0mm
- B: Φ 76.15mm
- C: Φ 111.0mm
- D: Φ 141.0mm

8" MOTOR

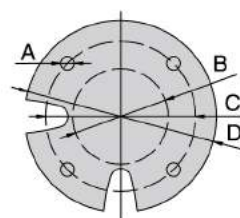

- A: Φ 20.0mm
- B: Φ 127.0mm
- C: Φ 152.5mm
- D: Φ 192.0mm

BASIC PARAMETERS

Model	Stage Number	Power	Motor		Pump					
			Length	Weight	Outlet Dia. DN	L1	Length L	Weight	Total Length	
		[KW]	[HP]	[mm]	[kg]	[inch]	[mm]	[mm]	[kg]	[mm]
VP50-2	2	3.7	5	600	39.5	3"	165	330	12	930
VP50-3	3	5.5	7.5	631	43.2	3"	165	387	15	1018
VP50-4	4	7.5	10	660	45.5	3"	165	444	17	1104
VP50-5	5	7.5	10	660	45.5	3"	165	501	20	1161
VP50-6	6	11	15	730	53	3"	165	558	23	1288
VP50-7	7	11	15	730	53	3"	165	615	25	1345
VP50-8	8	15	20	785	59	3"	165	672	27	1457
VP50-9	9	15	20	785	59	3"	165	729	30	1514
VP50-10	10	18.5	25	860	66.5	3"	165	786	32	1646
VP50-11	11	18.5	25	860	66.5	3"	165	843	34	1703
VP50-12	12	22	30	920	72.5	3"	165	900	36	1820
VP50-13	13	22	30	920	72.5	3"	165	957	38	1877
VP50-14	14	30	40	1050	85	3"	165	1014	40	2064
VP50-15	15	30	40	1050	85	3"	165	1071	42	2121
VP50-16	16	30	40	1050	85	3"	165	1128	44	2178
VP50-17	17	30	40	1050	85	3"	165	1185	47	2235
VP50-18	18	37	50	1180	98	3"	165	1242	49	2422



CAST SS SUBMERSIBLE PUMP

VP SERIES

IV、PERFORMANCE CURVE CHART

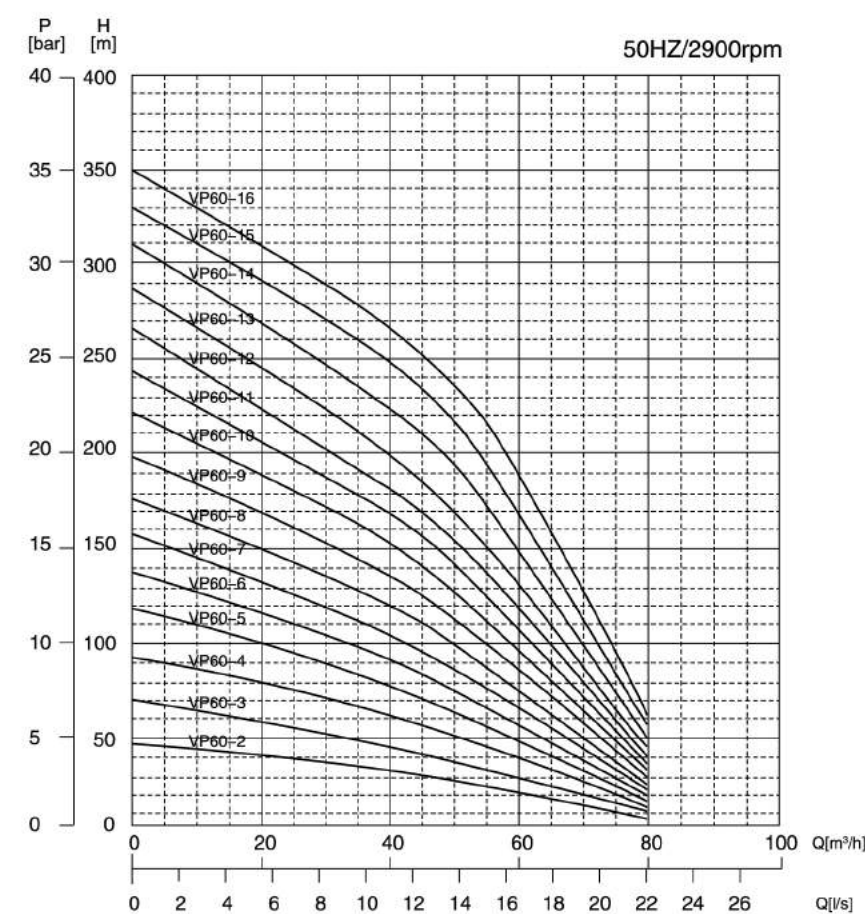

6" MOTOR

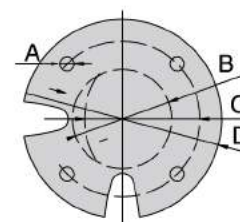

- A: Φ 14.0mm
- B: Φ 76.15mm
- C: Φ 111.0mm
- D: Φ 141.0mm

8" MOTOR

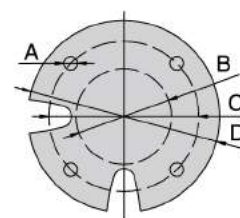

- A: Φ 20.0mm
- B: Φ 127.0mm
- C: Φ 152.5mm
- D: Φ 192.0mm

BASIC PARAMETERS

Model	Stage Number	Power	Motor		Pump					
			Length	Weight	Outlet Dia. DN	L1	Length L	Weight	Total Length	
		[KW]	[HP]	[mm]	[kg]	[inch]	[mm]	[mm]	[kg]	[mm]
VP60-2	2	5.5	7.5	631	43.2	4"	165	340	12	971
VP60-3	3	7.5	10	660	45.5	4"	165	400	15	1060
VP60-4	4	7.5	10	660	45.5	4"	165	460	17	1120
VP60-5	5	11	15	730	53	4"	165	520	20	1250
VP60-6	6	11	15	730	53	4"	165	580	22	1310
VP60-7	7	15	20	785	59	4"	165	640	24	1425
VP60-8	8	18.5	25	860	66.5	4"	165	700	27	1560
VP60-9	9	22	30	920	72.5	4"	165	760	30	1680
VP60-10	10	22	30	920	72.5	4"	165	820	32	1740
VP60-11	11	22	30	920	72.5	4"	165	880	34	1800
VP60-12	12	30	40	1050	85	4"	165	940	36	1990
VP60-13	13	30	40	1050	85	4"	165	1000	38	2050
VP60-14	14	37	50	1180	98	4"	165	1060	40	2240
VP60-15	15	37	50	1180	98	4"	165	1120	42	2300
VP60-16	16	37	50	1180	98	4"	165	1180	48	2360



CAST SS SUBMERSIBLE PUMP

VP SERIES

IV、PERFORMANCE CURVE CHART

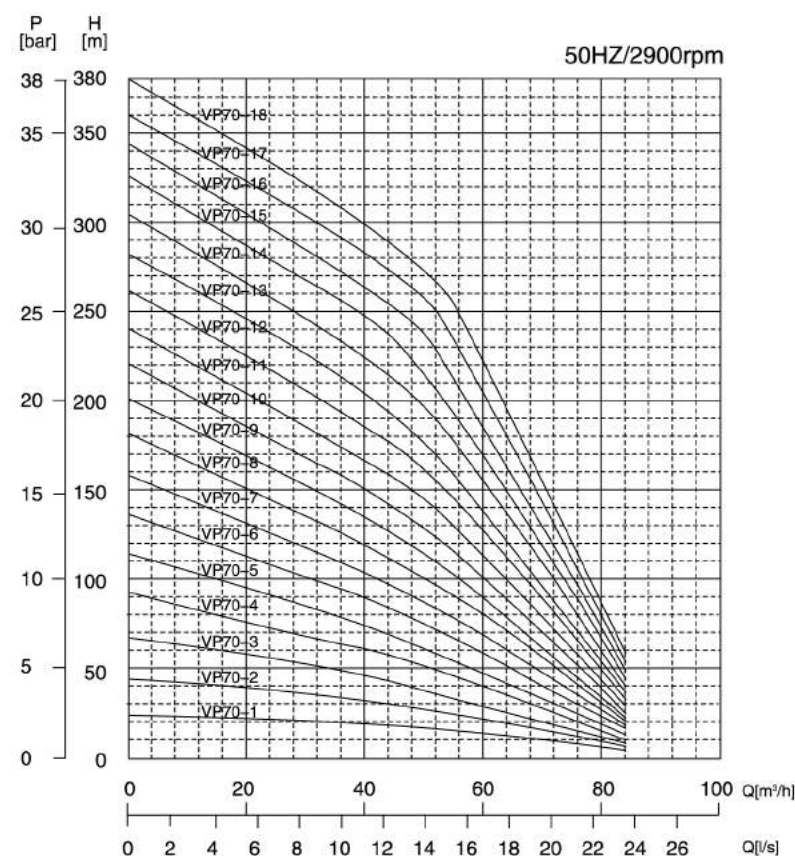

6" MOTOR

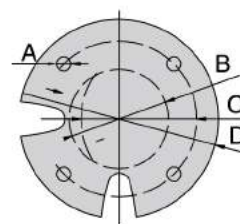

- A: Φ 14.0mm
- B: Φ 76.15mm
- C: Φ 111.0mm
- D: Φ 141.0mm

8" MOTOR

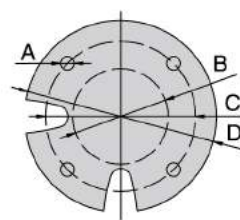

- A: Φ 20.0mm
- B: Φ 127.0mm
- C: Φ 152.5mm
- D: Φ 192.0mm

BASIC PARAMETERS

Model	Stage Number	Power		Motor		Pump				
		[KW]	[HP]	Length [mm]	Weight [kg]	Outlet Dia. DN [inch]	L1 [mm]	Length L [mm]	Weight [kg]	Total Length [mm]
VP70-1	1	3.7	5.5	600	39.5	4"	165	280	9	880
VP70-2	2	5.5	7.5	631	43.2	4"	165	340	12	971
VP70-3	3	7.5	10	660	45.5	4"	165	400	15	1060
VP70-4	4	11	15	730	53	4"	165	460	17	1190
VP70-5	5	11	15	730	53	4"	165	520	20	1250
VP70-6	6	15	20	785	59	4"	165	580	22	1365
VP70-7	7	18.5	25	860	66.5	4"	165	640	24	1500
VP70-8	8	18.5	25	860	66.5	4"	165	700	27	1560
VP70-9	9	22	30	920	72.5	4"	165	760	30	1680
VP70-10	10	22	30	920	72.5	4"	165	820	32	1740
VP70-11	11	30	40	1050	85	4"	165	880	36	1930
VP70-12	12	30	40	1050	85	4"	165	940	38	1990
VP70-13	13	37	50	1180	98	4"	165	1000	40	2180
VP70-14	14	37	50	1180	98	4"	165	1060	42	2240
VP70-15	15	37	50	1180	98	4"	165	1120	45	2300
VP70-16	16	45	60	1270	113	4"	165	1180	47	2450
VP70-17	17	45	60	1270	113	4"	165	1240	50	2510
VP70-18	18	45	60	1270	113	4"	165	1300	53	2570



CAST SS SUBMERSIBLE PUMP

VP SERIES

IV、PERFORMANCE CURVE CHART

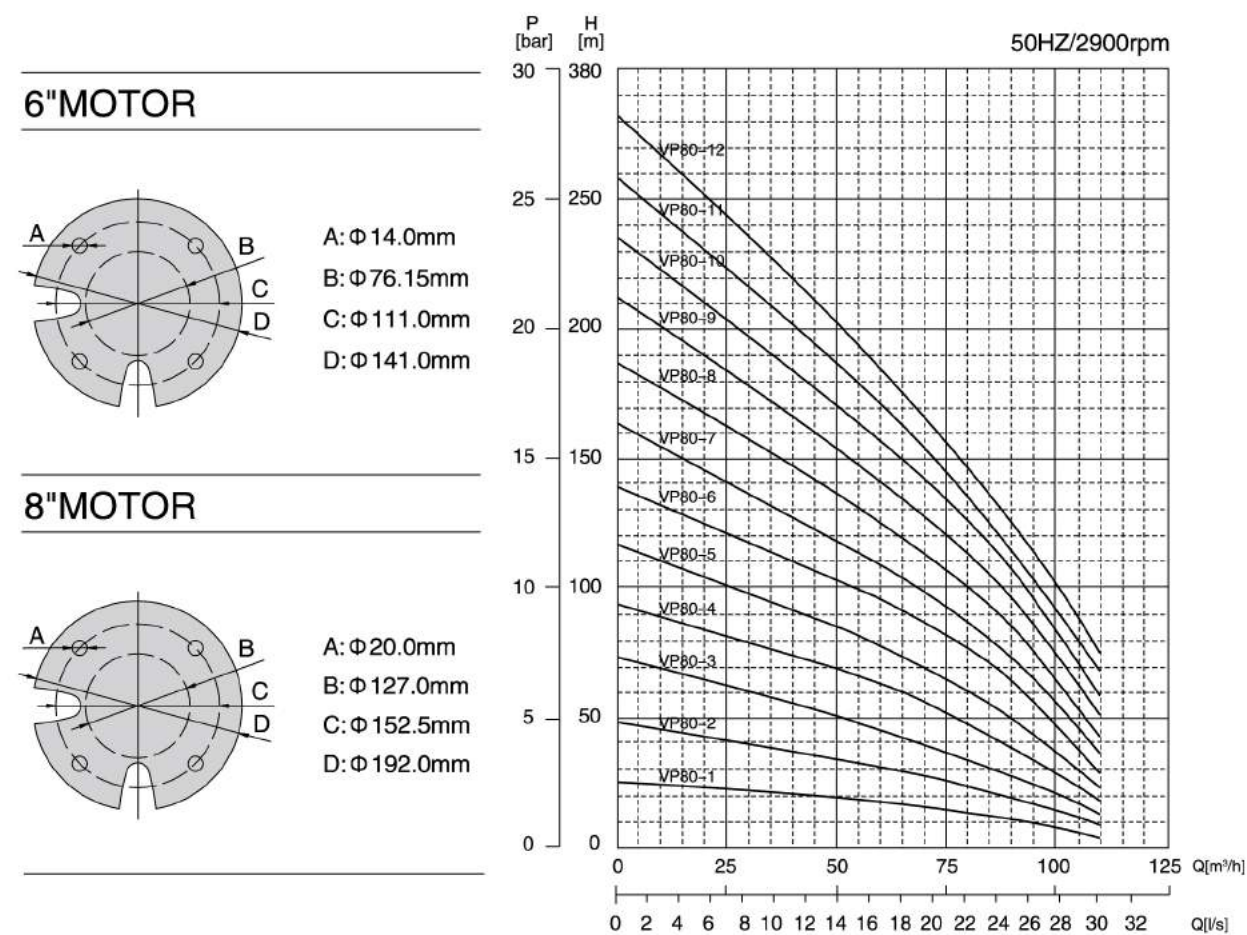

6" MOTOR

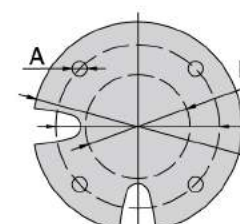

- A: Φ 14.0mm
- B: Φ 76.15mm
- C: Φ 111.0mm
- D: Φ 141.0mm

8" MOTOR

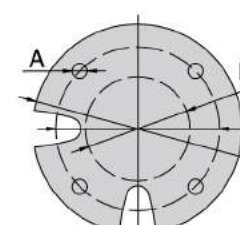

- A: Φ 20.0mm
- B: Φ 127.0mm
- C: Φ 152.5mm
- D: Φ 192.0mm

BASIC PARAMETERS

Model	Stage Number	Power		Motor		Pump					
		[KW]	[HP]	Length [mm]	Weight [kg]	Outlet Dia. DN [inch]	L1 [mm]	L2 [mm]	Length L [mm]	Weight [kg]	Total Length [mm]
VP80-1	1	7.5	10	660	45.5	4"	175	165	320	18	980
VP80-2	2	11	15	730	53	4"	175	165	440	25	1170
VP80-3	3	15	20	785	59	4"	175	165	560	33	1345
VP80-4	4	18.5	25	860	66.5	4"	175	165	680	40	1540
VP80-5	5	22	30	920	72.5	4"	175	165	800	47	1720
VP80-6	6	30	40	1050	85	4"	175	165	920	54	1970
VP80-7	7	30	40	1050	85	4"	210	165	1164	64	2214
VP80-8	8	37	50	1180	98	4"	210	165	1286	71	2466
VP80-9	9	45	60	1270	113	4"	210	165	1408	78	2678
VP80-10	10	45	60	1270	113	4"	210	165	1530	85	2800
VP80-11	11	55	75	1350	192	4"	210	165	1652	93	3002
VP80-12	12	55	75	1350	192	4"	210	165	1774	95	3124

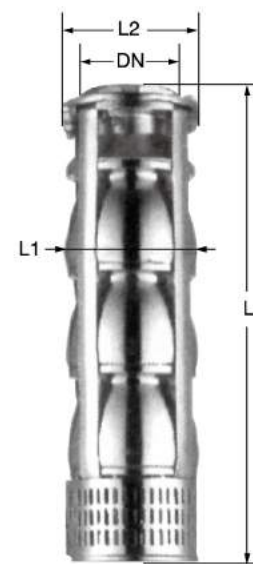

CAST SS SUBMERSIBLE PUMP

VP SERIES

IV、PERFORMANCE CURVE CHART

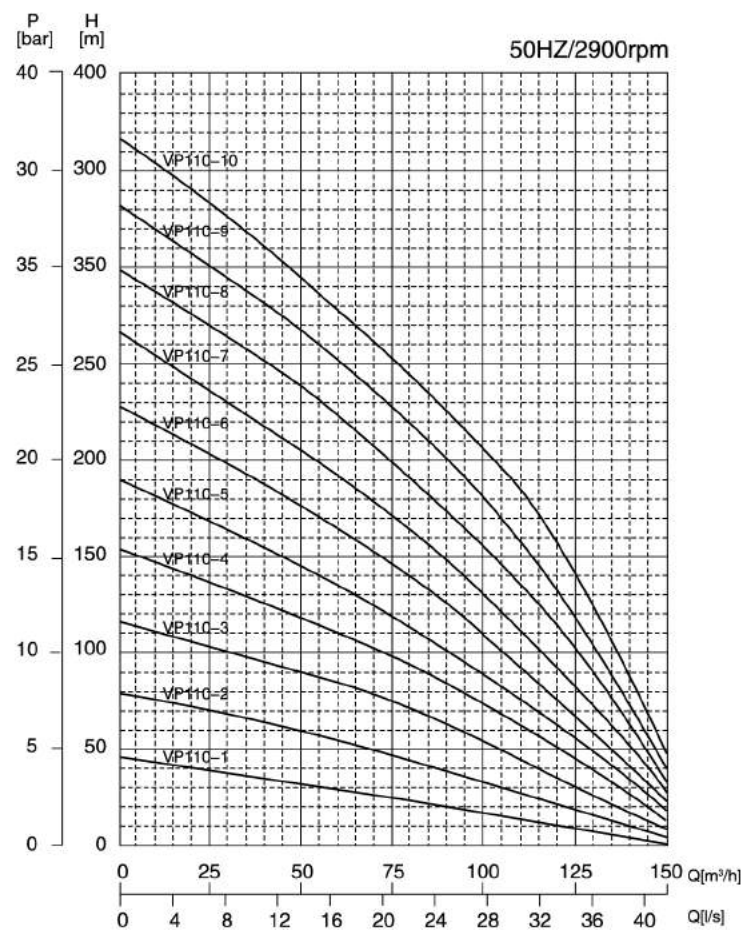

6" MOTOR

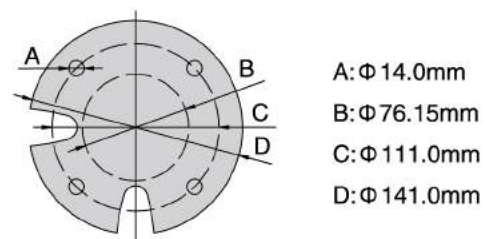

8" MOTOR

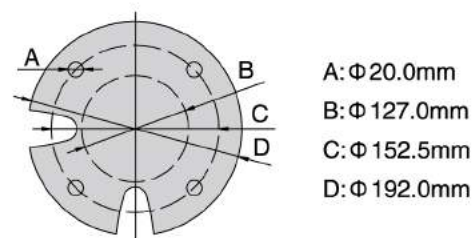

BASIC PARAMETERS

Model	Stage Number	Power		Length		Weight		Outlet Dia. DN		Pump		Total Length
		[KW]	[HP]	[mm]	[kg]	[mm]	[kg]	[mm]	[mm]	L1	L2	
6D	VP110-1	1	7.5	10	660	45.5	DN100	210	205	413	31	1073
	VP110-2	2	15	20	785	59	DN100	210	205	496	39	1281
	VP110-3	3	22	30	920	72.5	DN100	210	205	579	46	1499
	VP110-4	4	30	40	1050	85	DN100	210	205	662	54	1712
	VP110-5	5	37	50	1180	98	DN100	210	205	745	62	1925
	VP110-6	6	45	60	1270	113	DN100	210	205	828	70	2098
	VP110-7	7	55	75	1350	128	DN100	210	205	911	77	2261
	VP110-8	8	75	100	1590	237	DN100	210	205	994	85	2584
	VP110-9	9	93	125	1830	283	DN100	210	205	1077	93	2907
	VP110-10	10	93	125	1830	283	DN100	210	205	1160	100	2990

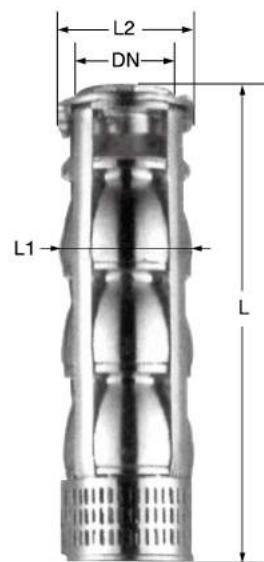
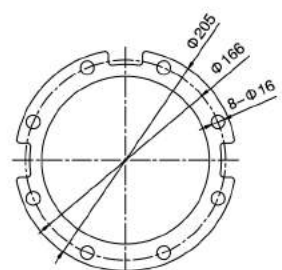

CAST SS SUBMERSIBLE PUMP

VP SERIES

IV、PERFORMANCE CURVE CHART

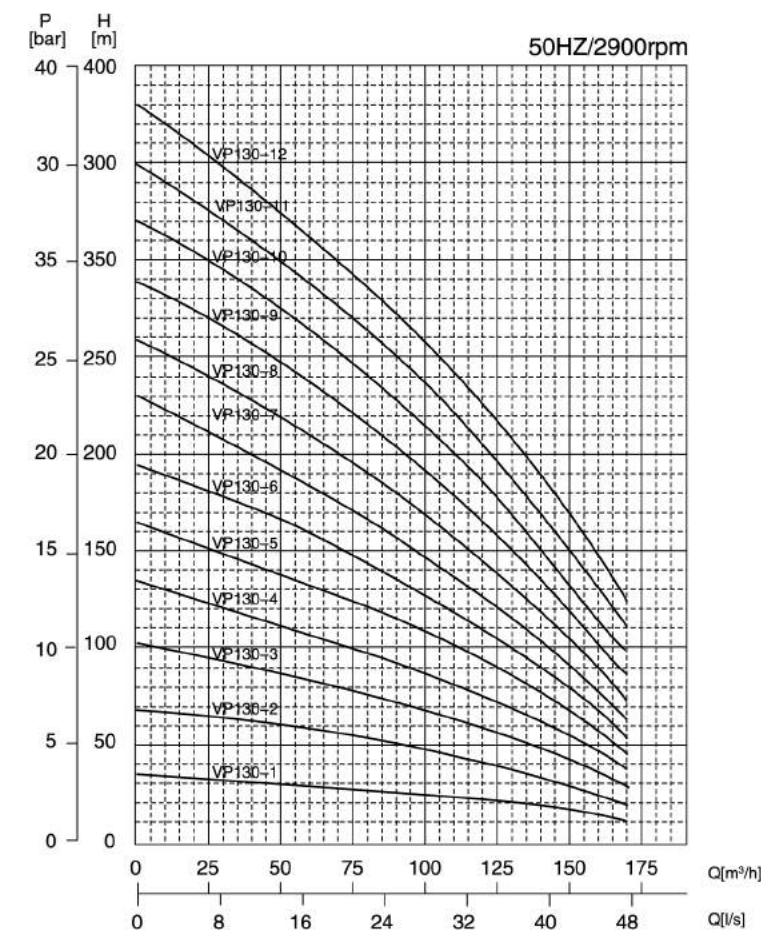

6" MOTOR

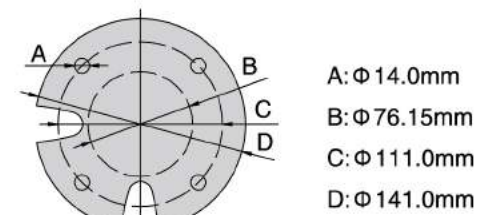

8" MOTOR

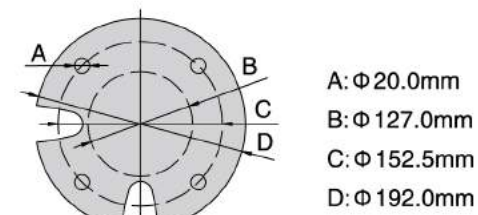

BASIC PARAMETERS

Model	Stage Number	Power		Length		Weight		Outlet Dia. DN		Pump		Total Length
		[KW]	[HP]	[mm]	[kg]	[mm]	[kg]	[mm]	[mm]	L1	L2	
6D	VP130-1	1	11	15	730	53	DN125	210	205	478	36	1208
	VP130-2	2	18.5	25	860	66.5	DN125	210	205	561	44	1421
	VP130-3	3	30	40	1050	85	DN125	210	205	644	52	1634
	VP130-4	4	37	50	1180	98	DN125	210	205	727	60	1847
	VP130-5	5	45	60	1270	113	DN125	210	205	810	68	2060
	VP130-6	6	55	75	1350	128	DN125	210	205	893	76	2273
	VP130-7	7	75	100	1590	237	DN125	210	205	976	84	2486
	VP130-8	8	75	100	1590	237	DN125	210	205	1059	92	2699
	VP130-9	9	93	125	1830	283	DN125	210	205	1142	100	2912
	VP130-10	10	93	125	1830	283	DN125	210	205	1225	108	3125
	VP130-11	11	93	125	1830	283	DN125	210	205	1308	116	3338
	VP130-12	12	110	150	2080	333	DN125	210	205	1391	124	3551

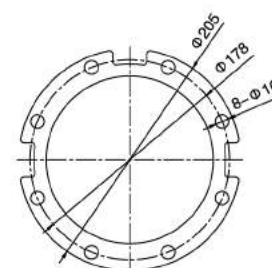

CAST SS SUBMERSIBLE PUMP

VP SERIES

IV、 PERFORMANCE CURVE CHART

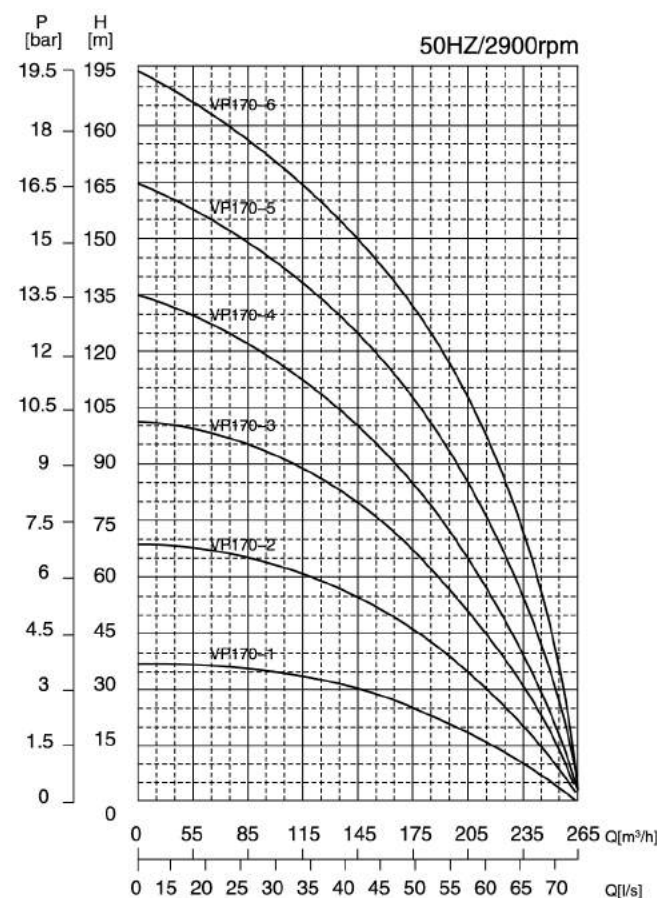

6" MOTOR

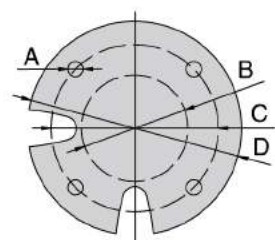

- A: Φ 14.0mm
- B: Φ 76.15mm
- C: Φ 111.0mm
- D: Φ 141.0mm

8" MOTOR

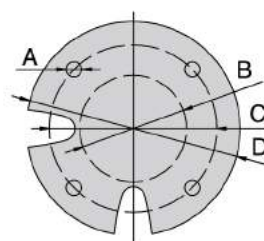

- A: Φ 20.0mm
- B: Φ 127.0mm
- C: Φ 152.5mm
- D: Φ 192.0mm

BASIC PARAMETERS

Model	Stage Number	Power		Length		Weight		Pump				
		[KW]	[HP]	[mm]	[kg]	Outlet Dia. DN	L1	L2	Length L	Weight	Total Length	
6D	VP170-1	1	18.5	20	860	66.5	DN150	265	278	687	47	1547
	VP170-2	2	30	40	1050	85	DN150	265	278	867	63	1917
	VP170-3	3	45	60	1270	113	DN150	265	278	1047	80	2317
	VP170-4	4	75	75	1590	237	DN150	265	278	1227	96	2817
8D	VP170-5	5	75	100	1590	237	DN150	265	278	1407	112	2997
	VP170-6	6	93	125	1830	283	DN150	265	278	1670	137	3500

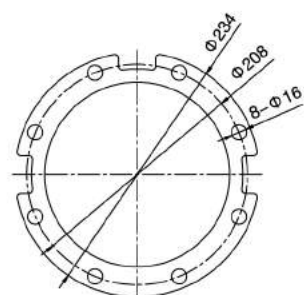

CAST SS SUBMERSIBLE PUMP

VP SERIES

IV、 PERFORMANCE CURVE CHART

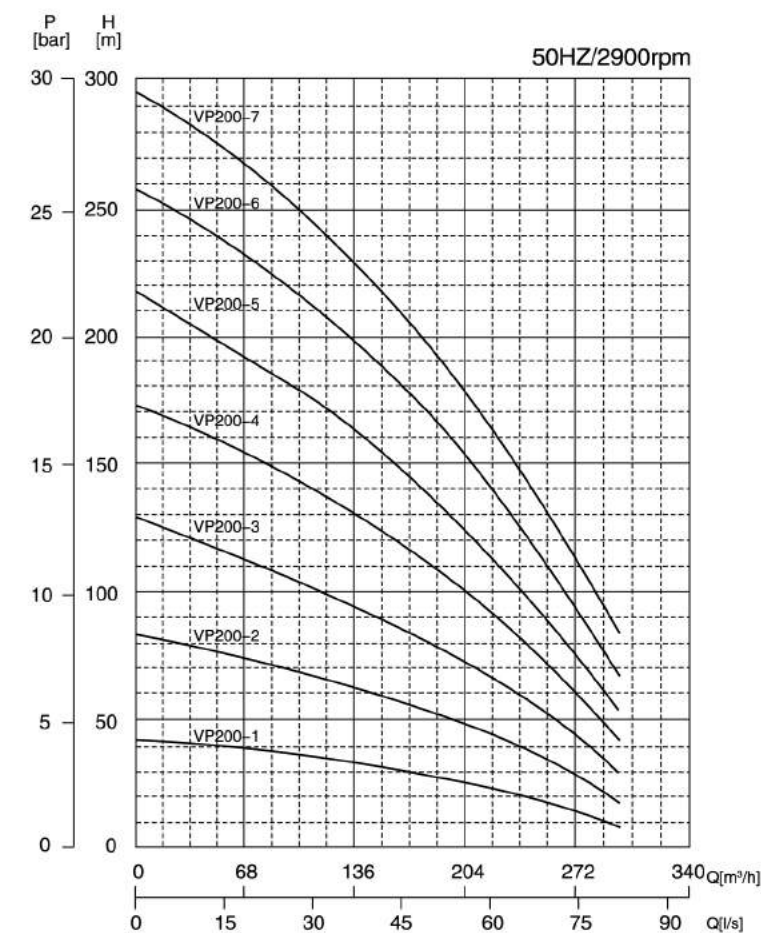

6" MOTOR

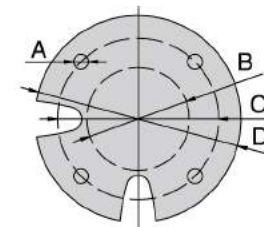

- A: Φ 14.0mm
- B: Φ 76.15mm
- C: Φ 111.0mm
- D: Φ 141.0mm

8" MOTOR

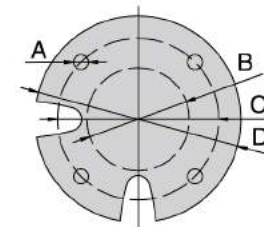

- A: Φ 20.0mm
- B: Φ 127.0mm
- C: Φ 152.5mm
- D: Φ 192.0mm

BASIC PARAMETERS

Model	Stage Number	Power		Length		Weight		Pump				
		[KW]	[HP]	[mm]	[kg]	Outlet Dia. DN	L1	L2	Length L	Weight	Total Length	
6D	VP200-1	1	18.5	25	860	66.5	DN150	265	278	687	47	1547
	VP200-2	2	37	50	1180	98	DN150	265	278	867	63	2047
	VP200-3	3	55	80	1350	192	DN150	265	278	1047	80	2387
	VP200-4	4	75	100	1590	237	DN150	265	278	1227	96	2817
8D	VP200-5	5	93	125	1830	283	DN150	265	278	1407	112	3237
	VP200-6	6	110	150	2060	333	DN150	265	278	1670	137	3730
10D	VP200-7	7	130	175	1870	435	DN150	265	278	1933	154	3803

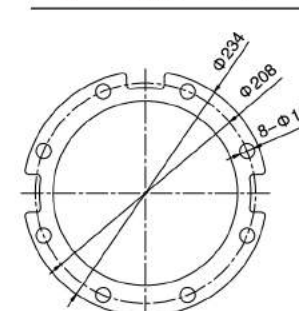

CAST SS SUBMERSIBLE PUMP

VP SERIES

IV、 PERFORMANCE CURVE CHART

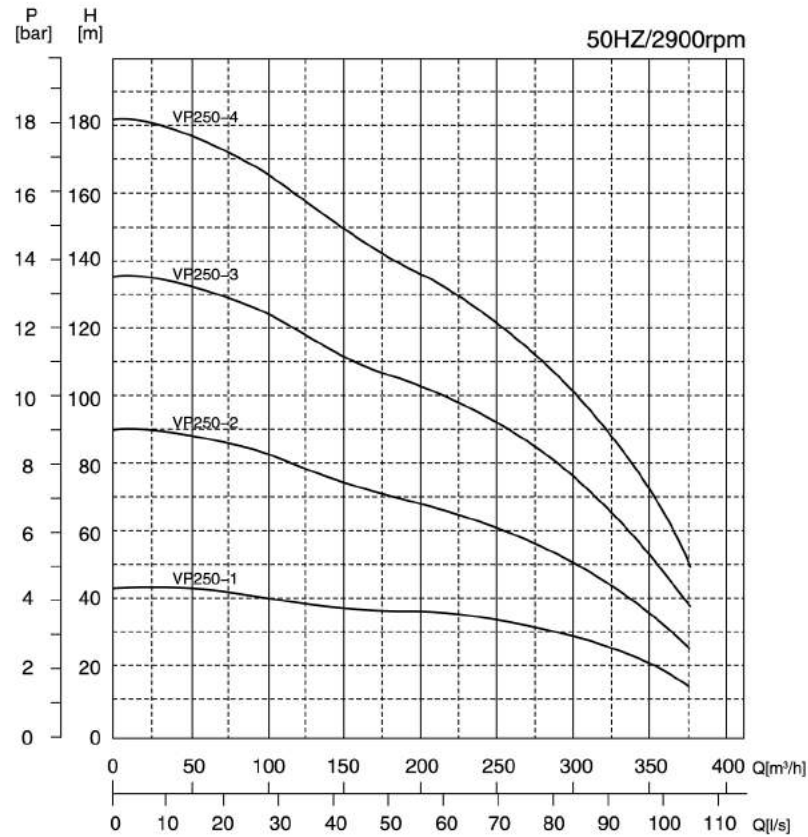

8" MOTOR

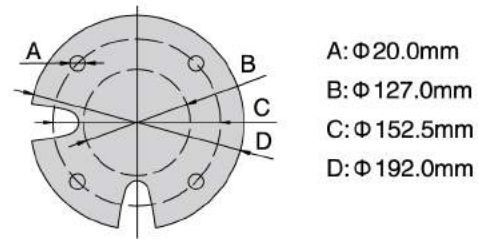

10" MOTOR

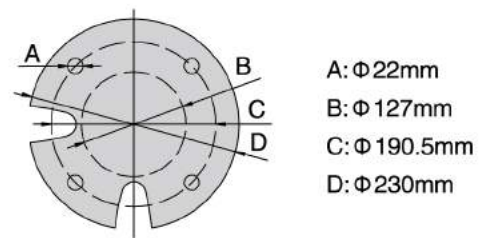

BASIC PARAMETERS

Model	Stage Number	Power	Motor		Pump							
			Length	Weight	Outlet Dia. DN	L1	L2	Length L	Weight	Total Length		
		[KW]	[HP]	[mm]	[kg]	[inch]	[mm]	[mm]	[mm]	[kg]	[mm]	
8D	VP250-1	1	37	40	1160	156	DN150	265	278	687	47	1847
	VP250-2	2	55	75	1350	192	DN150	265	278	867	64	2217
	VP250-3	3	93	125	1830	283	DN150	265	278	1047	80	2877
	VP250-4	4	110	150	2080	333	DN150	265	278	1310	105	3370

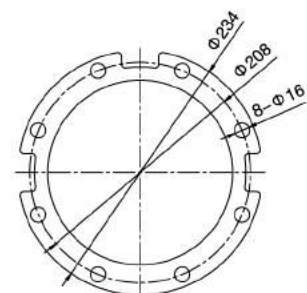

CAST SS SUBMERSIBLE PUMP

VP SERIES

IV、 PERFORMANCE CURVE CHART

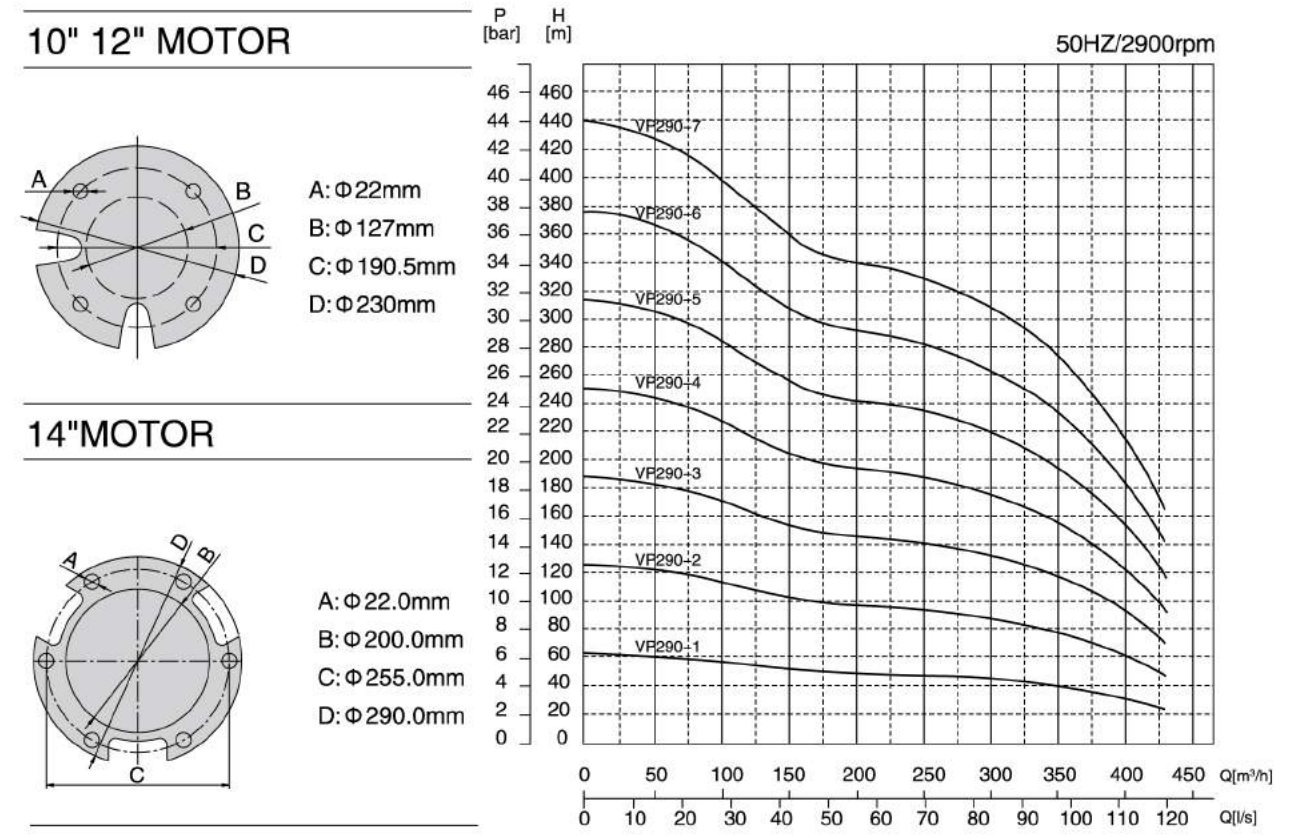

10" 12" MOTOR

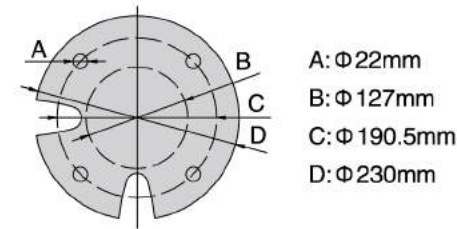

14" MOTOR

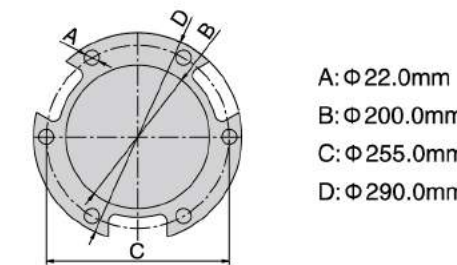

BASIC PARAMETERS

Model	Stage Number	Power	Motor		Pump							
			Length	Weight	Outlet Dia. DN	L1	L2	Length L	Weight	Total Length		
		[KW]	[HP]	[mm]	[kg]	[inch]	[mm]	[mm]	[mm]	[kg]	[mm]	
8D	VP290-1	1	75	100	1590	237	DN175	310	280	876	99	2466
	VP290-2	2	110	150	2060	333	DN175	310	280	1076	129	3136
10D	VP290-3	3	150	200	2070	500	DN175	310	280	1276	158	3346
	VP290-4	4	185	250	2400	580	DN175	310	280	1476	188	3876
12D	VP290-5	5	220	300	2110	700	DN175	310	280	1676	217	3786
14D	VP290-6	6	300	400	2020	845	DN175	310	280	1876	247	3896
	VP290-7	7	350	500	2320	1010	DN175	310	280	2076	277	4396

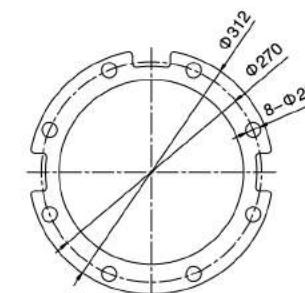

CAST SS SUBMERSIBLE PUMP

VP SERIES

IV、 PERFORMANCE CURVE CHART

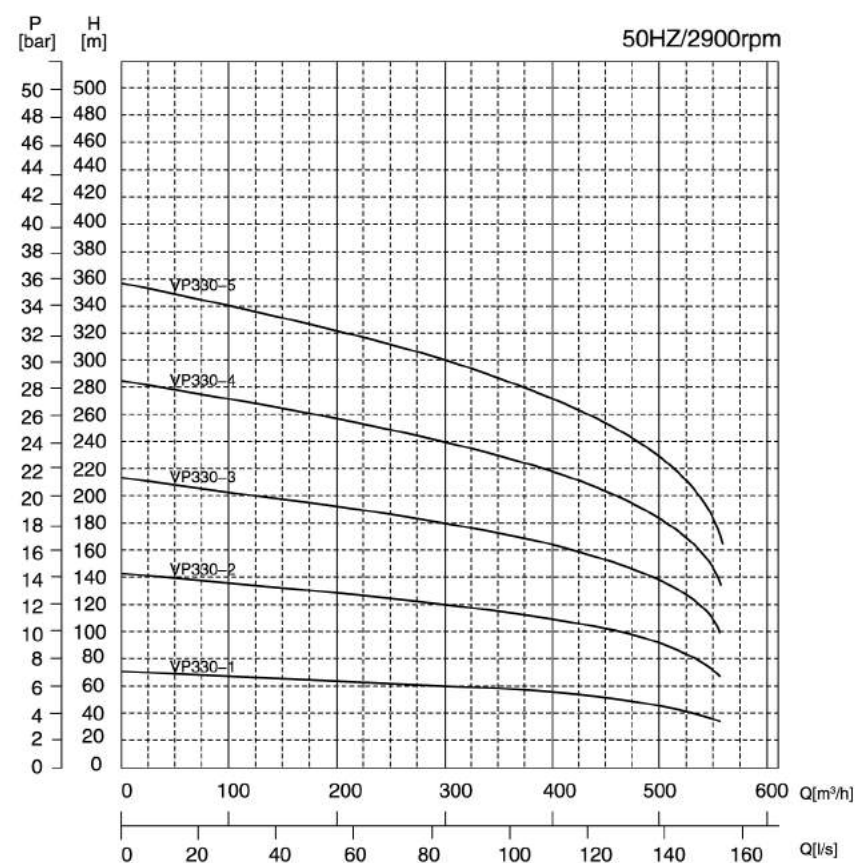

10" 12" MOTOR

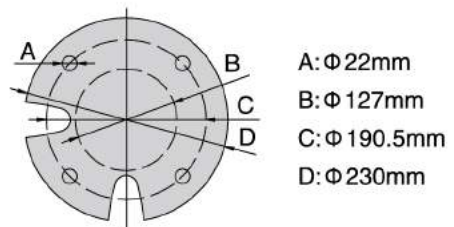

14" MOTOR

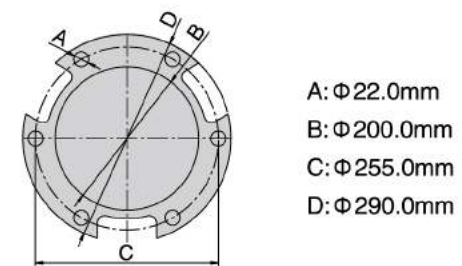

BASIC PARAMETERS

Model	Stage Number	Motor				Pump						
		Power [KW]	Power [HP]	Length [mm]	Weight [kg]	Outlet Dia. DN [inch]	L1 [mm]	L2 [mm]	Length L [mm]	Weight [kg]	Total Length [mm]	
8D	VP330-1	1	93	125	1830	283	DN175	310	280	876	96	2706
10D	VP330-2	2	150	200	2070	500	DN175	310	280	1076	123	3146
12D	VP330-3	3	220	300	2110	700	DN175	310	280	1276	149	3386
14D	VP330-4	4	300	340	2020	845	DN175	310	280	1476	176	3496
	VP330-5	5	350	500	2320	1010	DN175	310	280	1676	203	3996

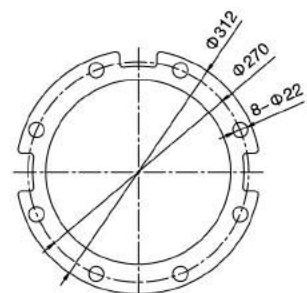

CAST SS SUBMERSIBLE PUMP

VP SERIES

IV、 PERFORMANCE CURVE CHART

8" MOTOR

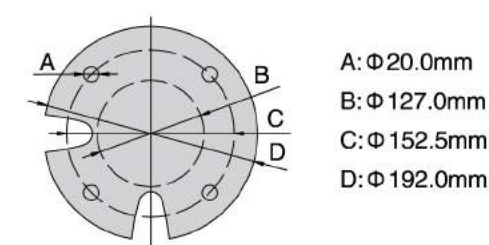

10" MOTOR

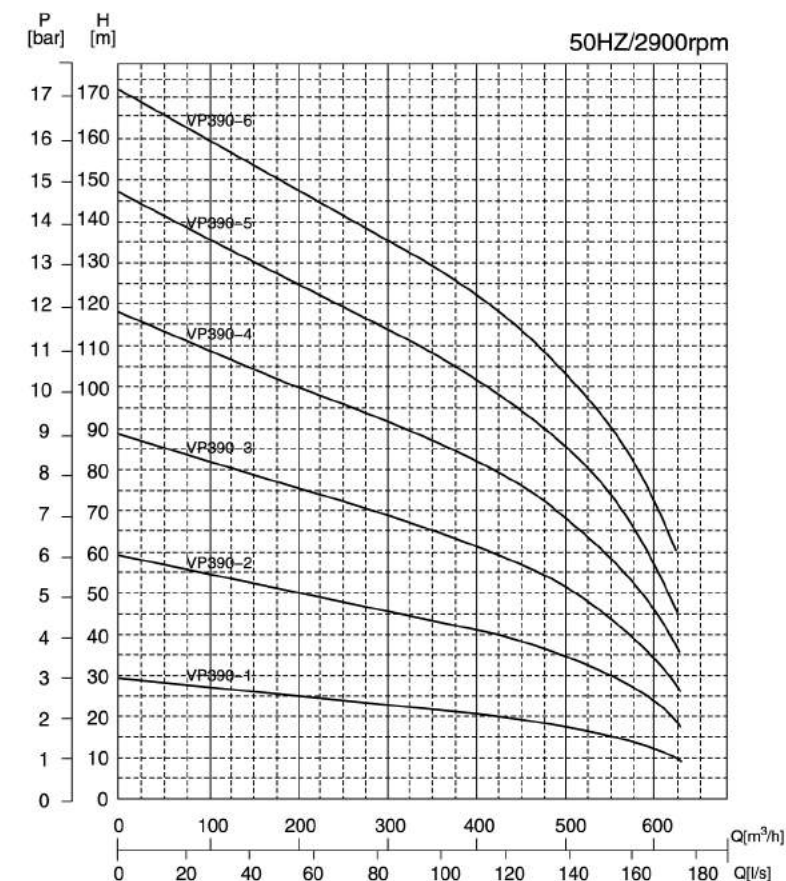
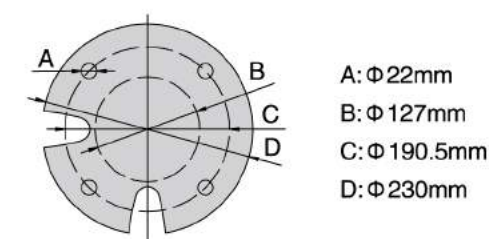

BASIC PARAMETERS

Model	Stage Number	Motor				Pump						
		Power [KW]	Power [HP]	Length [mm]	Weight [kg]	Outlet Dia. DN [inch]	L1 [mm]	L2 [mm]	Length L [mm]	Weight [kg]	Total Length [mm]	
8D	VP390-1	1	45	60	1270	177	DN175	310	280	876	96	2146
	VP390-2	2	75	100	1590	237	DN175	310	280	1076	123	2666
	VP390-3	3	110	150	2060	333	DN175	310	280	1276	149	3336
10D	VP390-4	4	130	180	1870	435	DN175	310	280	1476	176	3346
	VP390-5	5	150	200	2070	500	DN175	310	280	1676	203	3746
	VP390-6	6	185	260	2400	580	DN175	310	280	1876	233	4276

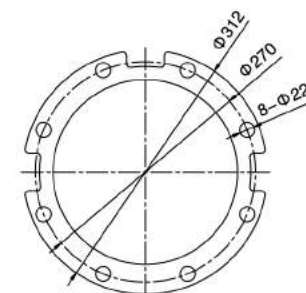

CAST SS SUBMERSIBLE PUMP

VP SERIES

IV、PERFORMANCE CURVE CHART

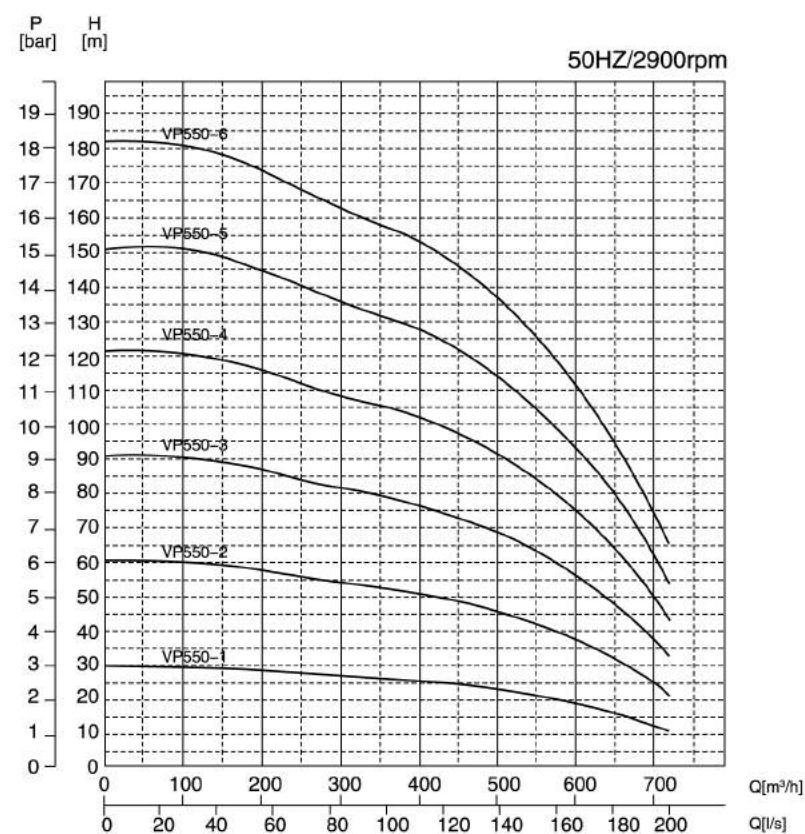

8" MOTOR

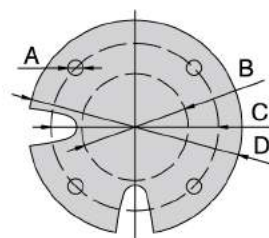

- A: $\Phi 20.0\text{mm}$
- B: $\Phi 127.0\text{mm}$
- C: $\Phi 152.5\text{mm}$
- D: $\Phi 192.0\text{mm}$

10"12" MOTOR

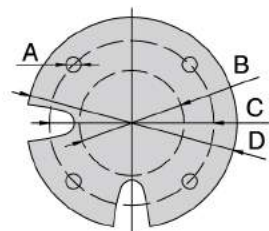

- A: $\Phi 22\text{mm}$
- B: $\Phi 127\text{mm}$
- C: $\Phi 190.5\text{mm}$
- D: $\Phi 230\text{mm}$

BASIC PARAMETERS											
Model	Stage Number	Power		Length		Weight		Pump			
		[KW]	[HP]	[mm]	[kg]	[mm]	[kg]	Outlet Dia. DN	L1	L2	Total Length
8D	VP550-1	55	75	1350	192	DN225	360	325	1043	140	2393
	VP550-2	93	125	1830	293	DN225	360	325	1295	183	3125
10D	VP550-3	130	180	1870	435	DN225	360	325	1547	226	3417
	VP550-4	185	260	2400	590	DN225	360	325	1799	269	4199
12D	VP550-5	220	300	2110	700	DN225	360	325	2051	312	4161
	VP550-6	250	340	2280	775	DN225	360	325	2303	355	4583

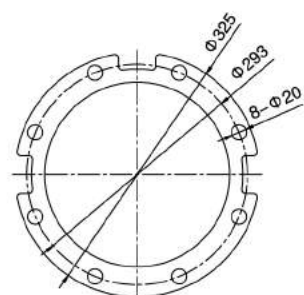

CAST SS SUBMERSIBLE PUMP

VP SERIES

IV、PERFORMANCE CURVE CHART

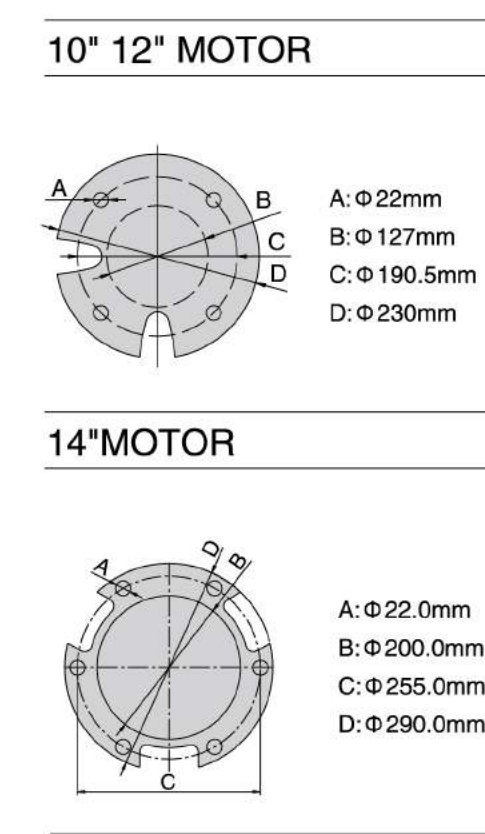

10" 12" MOTOR

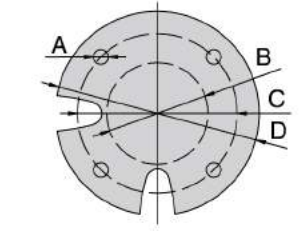

- A: $\Phi 22\text{mm}$
- B: $\Phi 127\text{mm}$
- C: $\Phi 190.5\text{mm}$
- D: $\Phi 230\text{mm}$

14" MOTOR

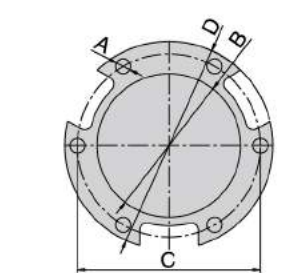

- A: $\Phi 22.0\text{mm}$
- B: $\Phi 200.0\text{mm}$
- C: $\Phi 255.0\text{mm}$
- D: $\Phi 290.0\text{mm}$

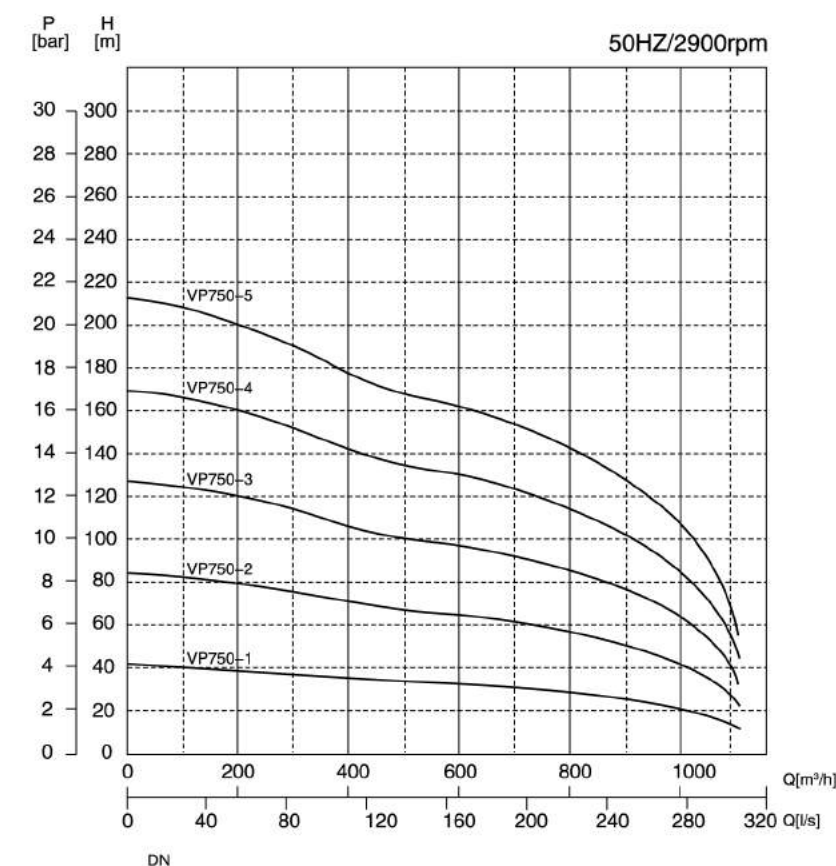

BASIC PARAMETERS											
Model	Stage Number	Power		Length		Weight		Pump			
		[KW]	[HP]	[mm]	[kg]	[mm]	[kg]	Outlet Dia. DN	L1	L2	Total Length
8D	VP750-1	93	125	1500	330	DN225	360	325	1043	140	2543
10D	VP750-2	185	260	2400	580	DN225	360	325	1295	183	3695
12D	VP750-3	250	340	2280	775	DN225	360	325	1547	226	3827
14D	VP750-4	350	500	2320	1010	DN225	360	325	1799	269	4119
	VP750-5	400	550	2460	1105	DN225	360	325	2051	312	4511

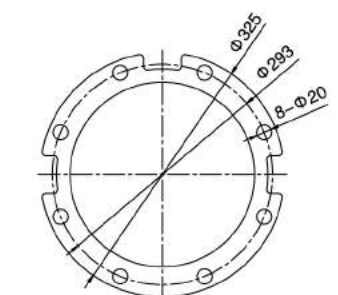

CAST SS SUBMERSIBLE PUMP

VP SERIES

IV、 PERFORMANCE CURVE CHART

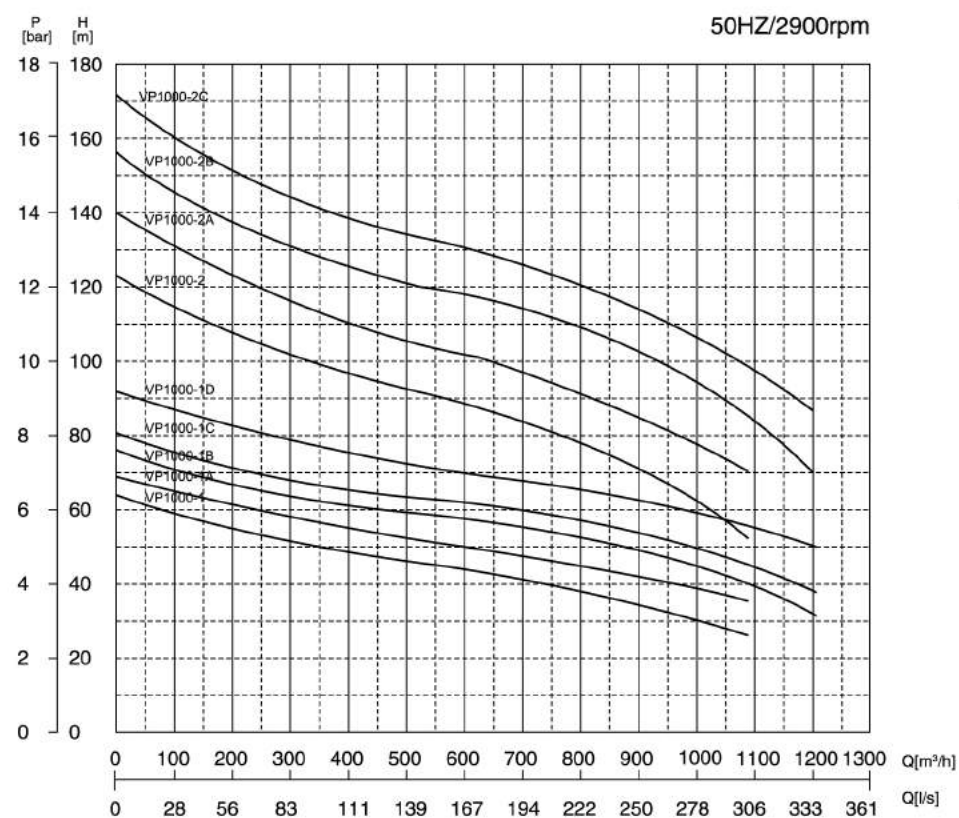

10" 12" MOTOR

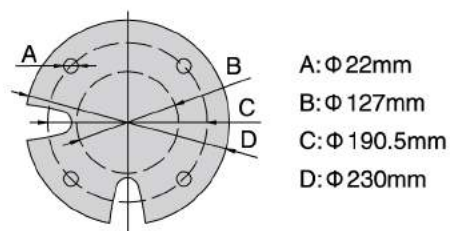

14" MOTOR

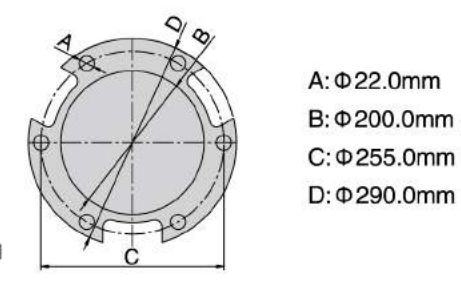

BASIC PARAMETERS

Model	Stage Number	Motor				Pump					
		Power [KW]	Power [HP]	Length [mm]	Weight [kg]	Outlet Dia. DN [inch]	L1 [mm]	L2 [mm]	Length L [mm]	Weight [kg]	Total Length [mm]
10D	VP1000-1	130	175	1870	435	DN300	381	360	1260	220	3130
	VP1000-1A	150	200	2070	500	DN300	381	360	1260	220	3330
	VP1000-1B	170	230	2220	540	DN300	381	360	1260	220	3480
	VP1000-1C	185	250	2400	580	DN300	381	360	1260	220	3660
12D	VP1000-1D	220	300	2110	700	DN300	381	360	1260	220	3370
	VP1000-2	250	340	2280	775	DN300	381	360	1545	300	3825
14D	VP1000-2A	300	475	2020	845	DN300	381	360	1545	300	3565
	VP1000-2B	350	540	2320	1010	DN300	381	360	1545	300	3865
	VP1000-2C	400	540	2480	1105	DN300	381	360	1545	300	4005

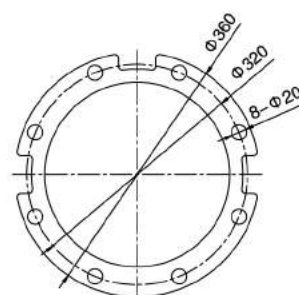

CAST SS SUBMERSIBLE PUMP 15"-24"



I、 Features

Description

Mixed-flow multistage pumps design suitable for lifting clean cold water from wells or tanks.

Construction:

- Pump bowls with shaft supported by rubber bushes lubricated by pumped liquid.
- Mixed-flow impellers, hydraulically and dynamically balanced.
- Submersible asynchronous motor, three-phase, rewindable, suitable to work immersed in water.
- Pump and motor coupled by a rigid coupling.
- Delivery flange: PN 16 (option PN 25)

VP

4"

6"

8"

10"

12"

14"

LVP

15/16"

19/22"

24"

OTHERS

CAST SS SUBMERSIBLE PUMP

LVP SERIES

II、 MATERIAL SPECIFICATIONS

	PART NAME	LVP	LVPC	LVPN	LVPD	LVPB
1	Bowl stage	AISI304	Cast iron	AISI316	Duplex Stainless steel	Bronze
2	Mixed-flow impeller	AISI304	Cast iron	AISI316	Duplex Stainless steel	Bronze
3	Pump shaft	AISI630	AISI304	AISI630	AISI904	AISI630
4	Bowl bearings	Rubber	Rubber	Teflon	Teflon	Teflon

Note: Available in stainless steel or bronze material products

III、 TECHNICAL SPECIFICATION

Operating limits	P:16 (Bar), max. 20 (Bar)	T: 0°C+ 60°C
Rotation direction	Clock-wise, seen from delivery	
Standards Performances	ISO 9906 grad.2	Flange: ISO 7005-2
Max Capacity: 1800m ³ /h	Max Head: 160m	

CAST SS SUBMERSIBLE PUMP

LVP SERIES

PERFORMANCE CURVE CHART

8" MOTOR

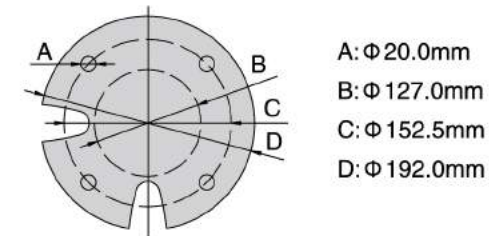

10"12" MOTOR

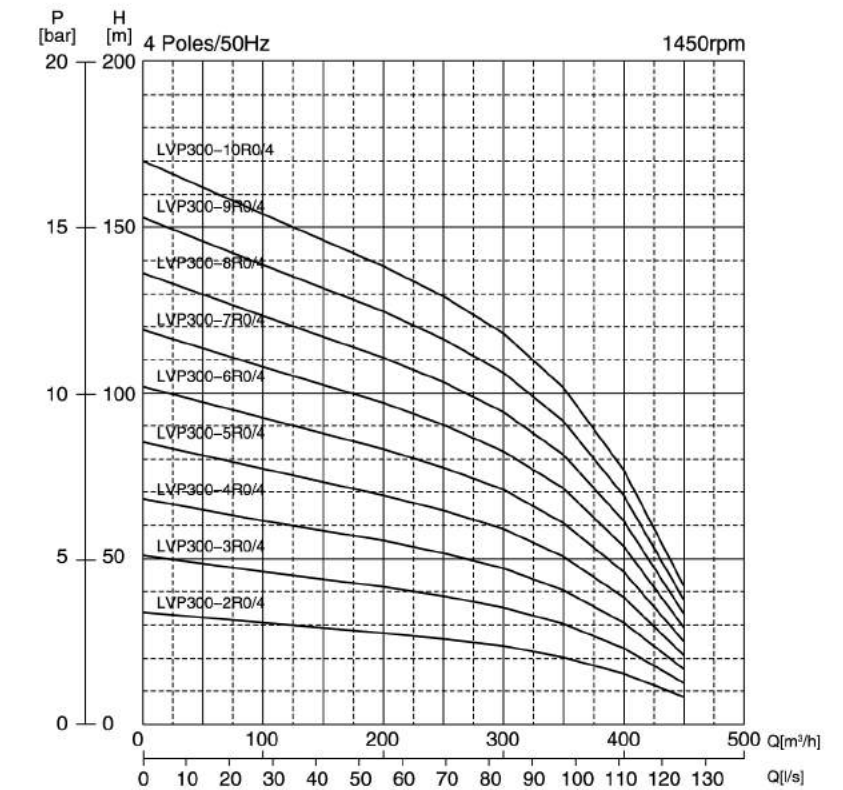
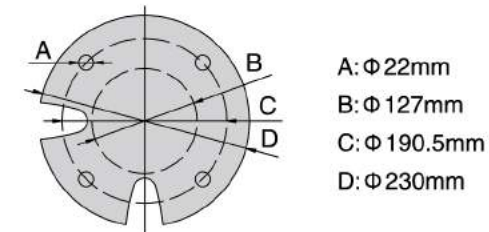

BASIC PARAMETERS												
Model	Stage Number	Power		Motor		Outlet Dia. DN	Pump		Length L	Weight	Total Length	
		[KW]	[HP]	Length [mm]	Weight [kg]		L1 [mm]	L2 [mm]				
8D	LVP300-2R20/4	2	30	40	1590	237	DN200	360	340	710	145	2300
	LVP300-3R20/4	3	45	60	1500	330	DN200	360	340	990	194	2460
	LVP300-4R20/4	4	55	80	1690	385	DN200	360	340	1210	243	2900
10D	LVP300-5R20/4	5	75	100	1870	435	DN200	360	340	1460	292	3330
	LVP300-6R20/4	6	92	125	2070	500	DN200	360	340	1710	341	3780
	LVP300-7R20/4	7	110	150	1880	605	DN200	360	340	1960	390	3840
12D	LVP300-8R20/4	8	110	150	1880	605	DN200	360	340	2210	439	4090
	LVP300-9R20/4	9	132	180	2110	700	DN200	360	340	2460	488	4570
	LVP300-10R20/4	10	132	180	2110	700	DN200	360	340	2710	537	4820

CAST SS SUBMERSIBLE PUMP

LVP SERIES

PERFORMANCE CURVE CHART

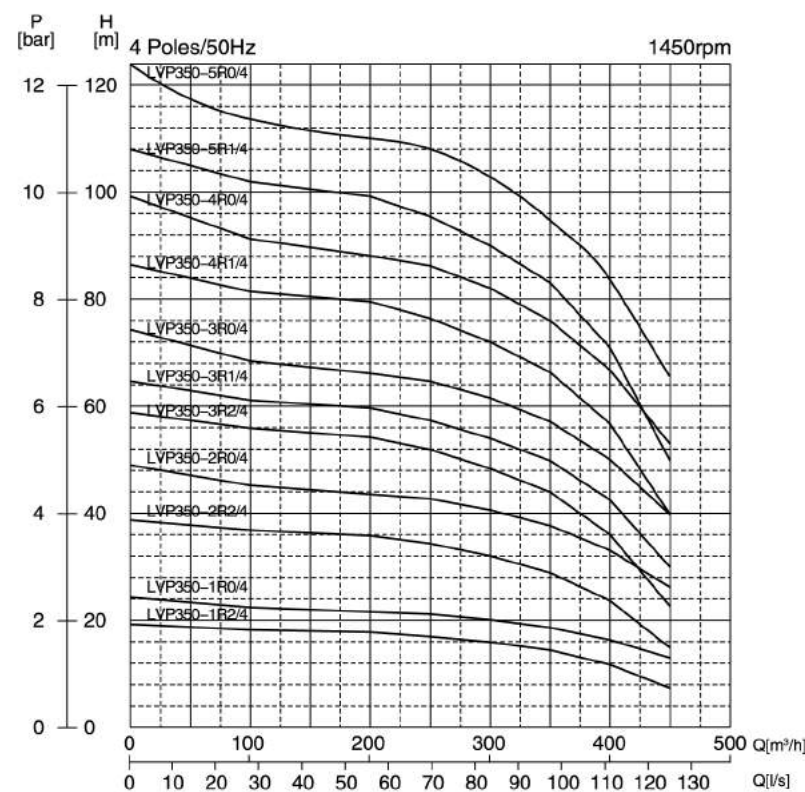

8" MOTOR

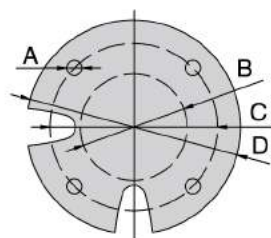

- A: Φ 20.0mm
- B: Φ 127.0mm
- C: Φ 152.5mm
- D: Φ 192.0mm

10"12" MOTOR

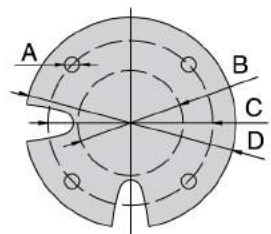

- A: Φ 22mm
- B: Φ 127mm
- C: Φ 190.5mm
- D: Φ 230mm

BASIC PARAMETERS

Model	Stage Number	Power		Motor		Pump						
		[KW]	[HP]	Length [mm]	Weight [kg]	Outlet Dia. DN [inch]	L1 [mm]	L2 [mm]	Length L [mm]	Weight [kg]	Total Length [mm]	
8D	LVP350-1R0/4	1	18.5	25	1270	177	DN200	400	340	460	96	1730
	LVP350-1R0/4	1	30	30	1590	237	DN200	400	340	460	96	2050
	LVP350-2R2/4	2	37	50	1830	283	DN200	400	340	710	145	2540
10D	LVP350-2R0/4	2	55	80	1690	385	DN200	400	340	710	145	2400
	LVP350-3R2/4	3	75	100	1870	435	DN200	400	340	960	194	2830
	LVP350-3R1/4	3	75	100	1870	435	DN200	400	340	960	194	2830
12D	LVP350-3R0/4	3	92	125	2070	500	DN200	400	340	960	194	3030
	LVP350-4R1/4	4	92	125	2070	500	DN200	400	340	1210	243	3280
	LVP350-4R0/4	4	110	150	1880	605	DN200	400	340	1210	243	3090
	LVP350-5R1/4	5	110	150	1880	605	DN200	400	340	1460	292	3340
LVP350-5R0/4	5	132	175	2110	700	DN200	400	340	1460	292	3570	



CAST SS SUBMERSIBLE PUMP

LVP SERIES

PERFORMANCE CURVE CHART

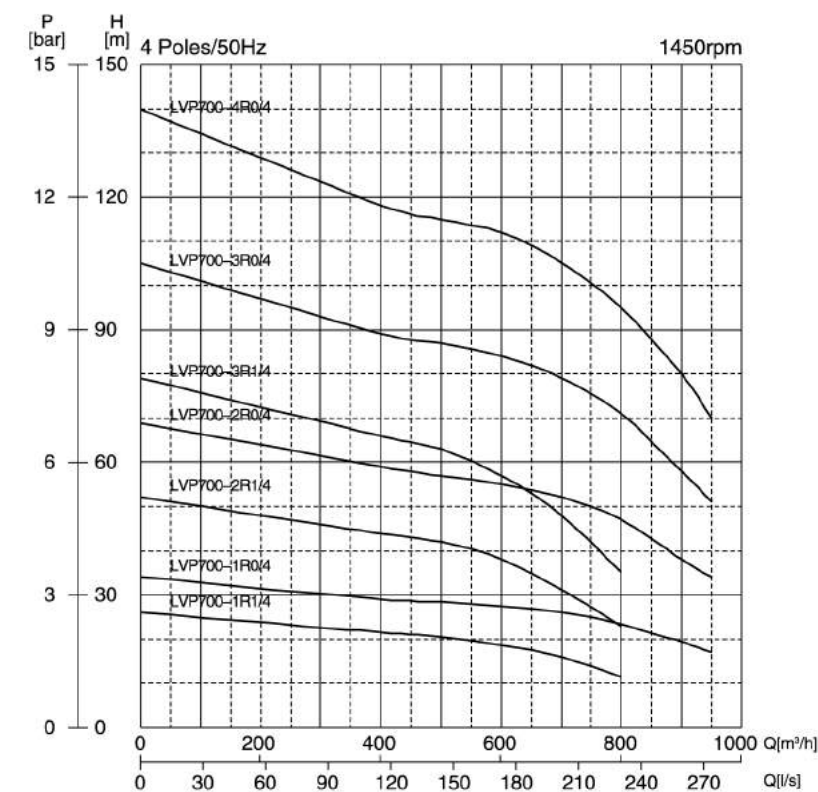

10" 12" MOTOR

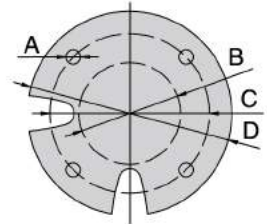

- A: Φ 22mm
- B: Φ 127mm
- C: Φ 190.5mm
- D: Φ 230mm

14" MOTOR

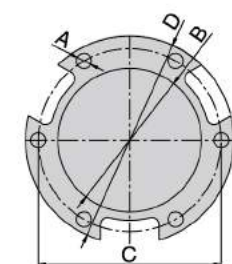

- A: Φ 22.0mm
- B: Φ 200.0mm
- C: Φ 255.0mm
- D: Φ 290.0mm

BASIC PARAMETERS

Model	Stage Number	Power		Motor		Pump						
		[KW]	[HP]	Length [mm]	Weight [kg]	Outlet Dia. DN [inch]	L1 [mm]	L2 [mm]	Length L [mm]	Weight [kg]	Total Length [mm]	
10D	LVP700-1R1/4	1	45	60	1500	330	DN250	470	405	460	96	1960
	LVP700-1R0/4	1	75	100	1870	435	DN250	470	405	460	96	2330
	LVP700-2R1/4	2	92	125	2070	500	DN250	470	405	710	145	2780
12D	LVP700-2R0/4	2	132	180	2110	700	DN250	470	405	710	145	2820
	LVP700-3R1/4	3	132	180	2110	700	DN250	470	405	960	194	3070
14D	LVP700-3R0/4	3	220	300	2160	950	DN250	470	405	960	194	3120
	LVP700-4R0/4	4	294	400	2460	1108	DN250	470	405	1210	243	3670



CAST SS SUBMERSIBLE PUMP

LVP SERIES

PERFORMANCE CURVE CHART

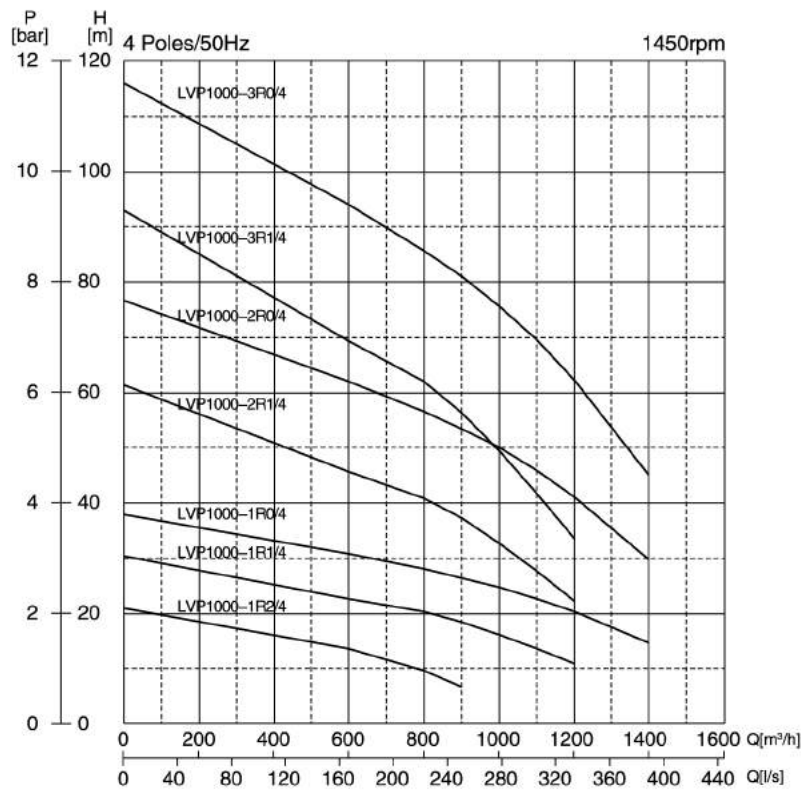

10" 12" MOTOR

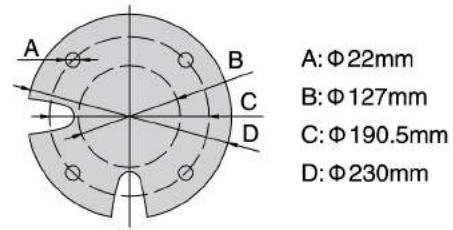

14" MOTOR

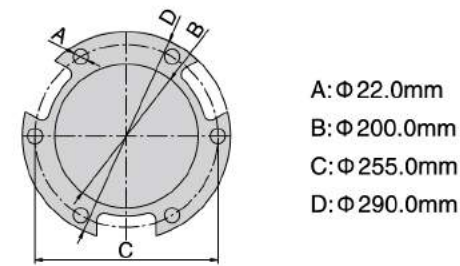

CAST SS SUBMERSIBLE PUMP

LVP SERIES

PERFORMANCE CURVE CHART

12" MOTOR

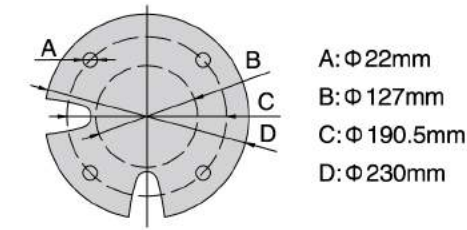

14" MOTOR

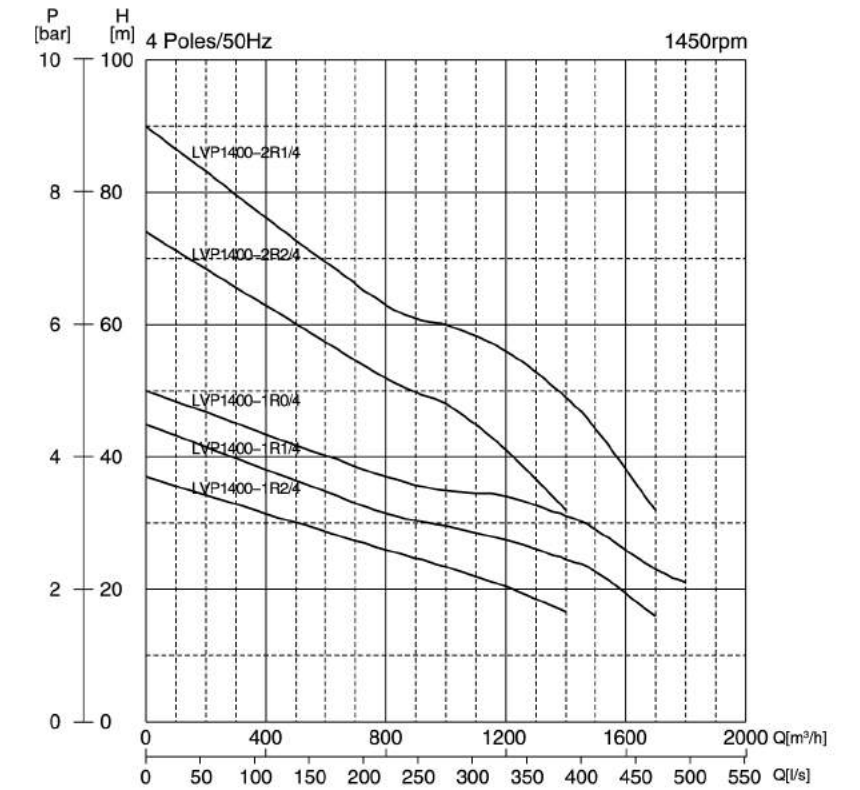
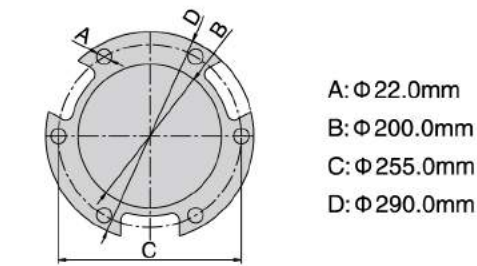

BASIC PARAMETERS

Model	Stage Number	Power		Length		Weight		Outlet Dia. DN		Pump		Total Length [mm]
		[KW]	[HP]	[mm]	[kg]	[mm]	[kg]	[mm]	[mm]	Length L	Weight	
10D	LVP1000-1R2/4	45	60	1500	330	DN300	540	460	460	96	1960	
	LVP1000-1R1/4	75	100	1870	435	DN300	540	460	460	96	2330	
12D	LVP1000-1R0/4	110	150	1880	605	DN300	540	460	460	96	2340	
	LVP1000-2R1/4	132	175	2110	700	DN300	540	460	710	145	2820	
14D	LVP1000-2R0/4	191	260	2020	885	DN300	540	460	710	145	2730	
	LVP1000-3R1/4	191	260	2020	885	DN300	540	460	960	194	2980	
	LVP1000-3R0/4	294	400	2460	1108	DN300	540	460	960	194	3420	



BASIC PARAMETERS

Model	Stage Number	Power		Length		Weight		Outlet Dia. DN		Pump		Total Length [mm]
		[KW]	[HP]	[mm]	[kg]	[mm]	[kg]	[mm]	[mm]	Length L	Weight	
12D	LVP1400-1R2/4	110	150	1880	605	DN300	580	460	457	109	2337	
	LVP1400-1R1/4	132	180	2110	700	DN300	580	460	457	109	2567	
14D	LVP1400-1R0/4	169	230	1910	776	DN300	580	460	457	109	2367	
	LVP1400-2R2/4	220	300	2160	950	DN300	580	460	707	158	2867	
	LVP1400-2R1/4	294	400	2460	1108	DN300	580	460	707	158	3167	



CAST SS SUBMERSIBLE PUMP

VP SERIES

V: INSTALLATION DIAGRAM (I)

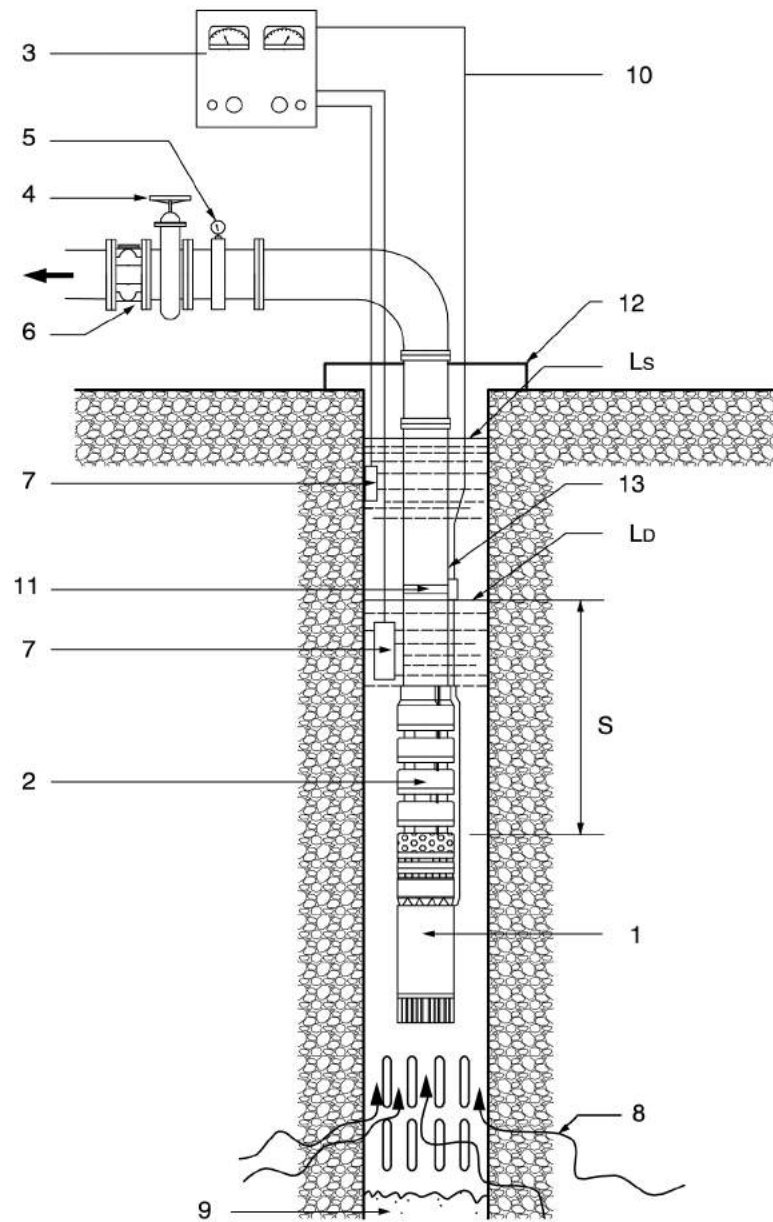

DESCRIPTION
Motor
Submersible pump
Electric Control Panel
Gate Valve
Pressure Gauge
Check Valve
Level Controller
Well Strainer
Well Bottom
Submersible Cable
Cable Clip
Pump Base
Lifting Pipe
Positive Suction Head
Static Level
Dynamic Level

CAST SS SUBMERSIBLE PUMP

VP SERIES

VI: INSTALLATION DIAGRAM (II)

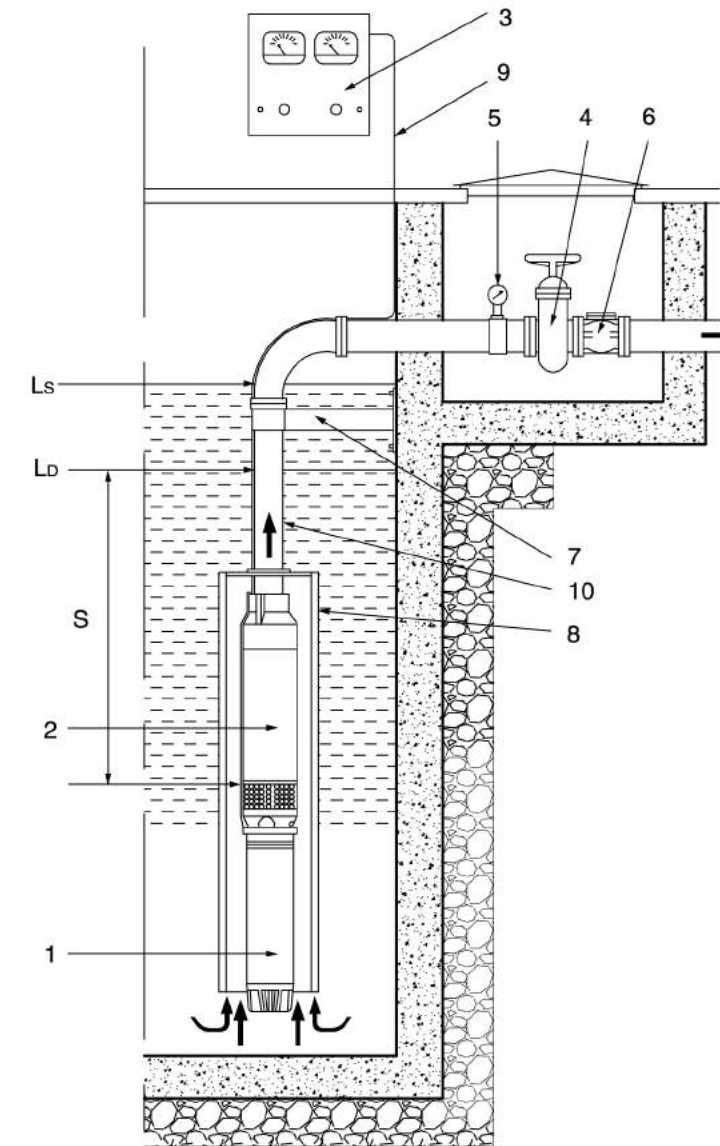

DESCRIPTION
Motor
Submersible pump
Electric Control Panel
Gate Valve
Pressure Gauge
Check Valve
Bracket
Diffuser
Submersible Cable
Lifting Pipe
Positive Suction Head
Static Level
Dynamic Level

VP

4"

6"

8"

10"

12"

14"

LVP

15/16"

19/22"

24"

OTHERS

CAST SS SUBMERSIBLE PUMP

VP SERIES

VII: INSTALLATION DIAGRAM

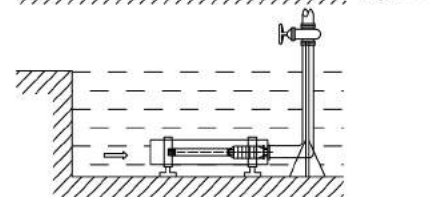
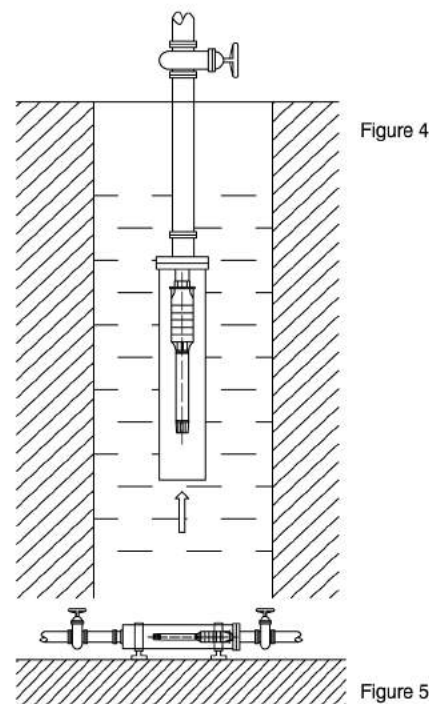
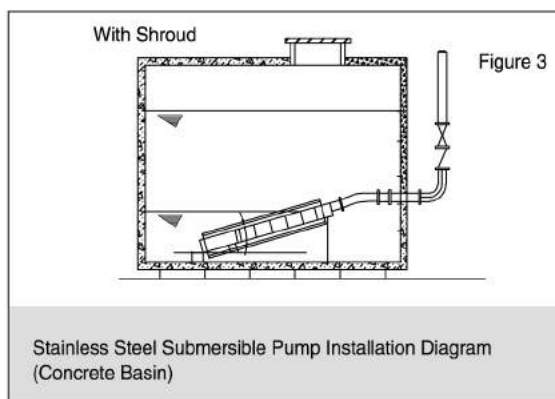
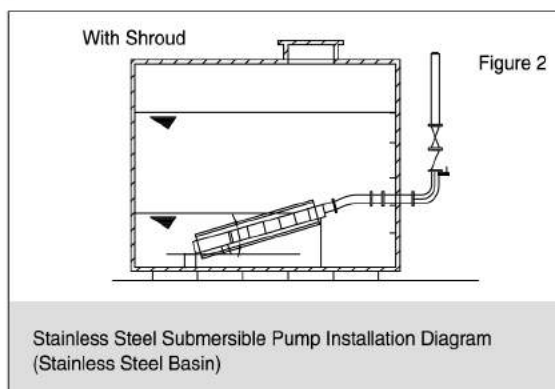
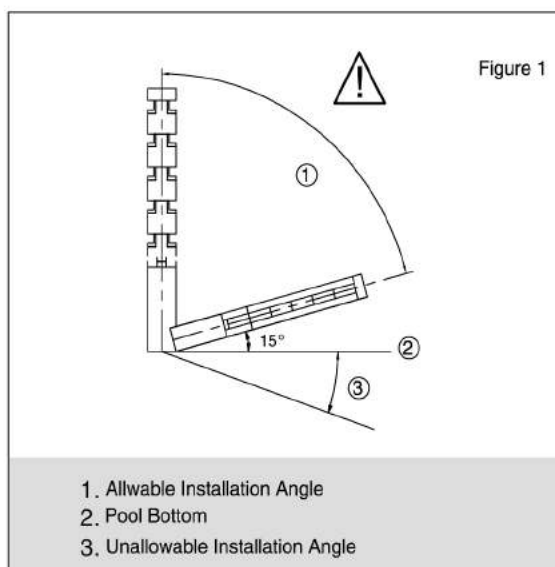

WARNING:

1. Installation angle is 15-90 degree. We suggest 15 degree.(Figure1)
2. As U-flo motor is submersible type, the lowest water level of the pool shall not be lower than the motor submerged depth.(Figure2、Figure3)
3. Reliable ground connection of motor shall be provided.
4. The use of motor in open type water shall install diversion sleeve. Consult U-flo local distributors for more details.(Figure4)

* Our company can provide horizontal or inclined installation of inner of pipe type pump unit as required, please make it clear when selecting model.(Figure5)

CAST SS SUBMERSIBLE PUMP

VP SERIES

VIII: PUMP BASE DIMENSION DRAWING

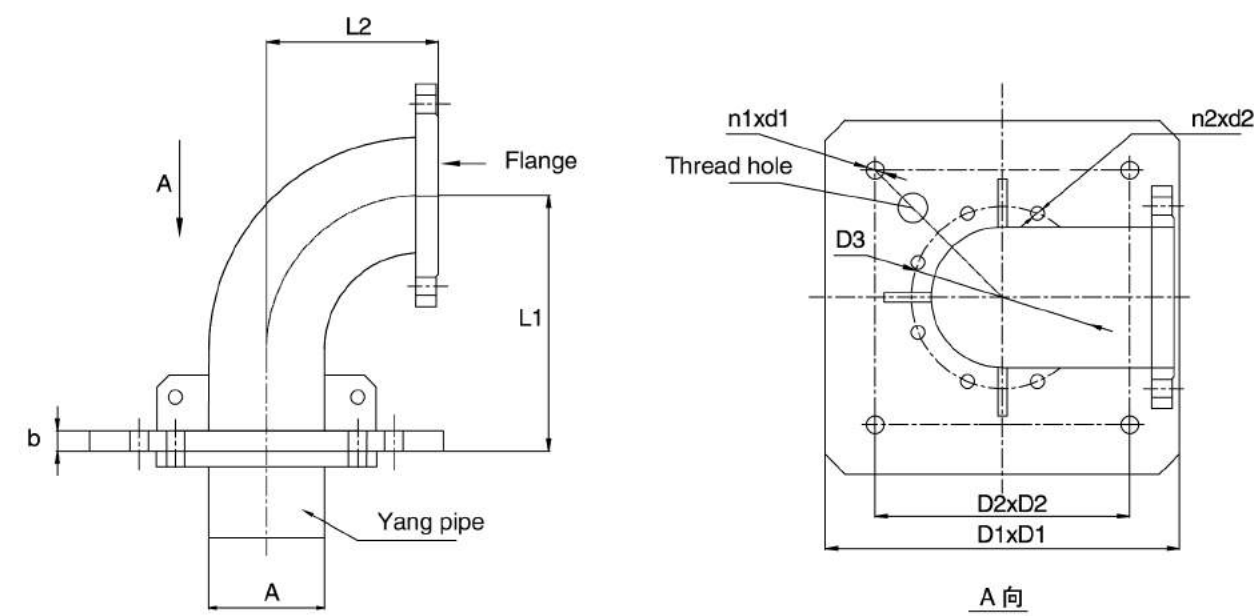

Note: Different base dimensions are as below:

GB										
DN	A	L1	L2	D1 × D1	D2 × D2	D3	b	n1 × d1	n2 × d2	
50	60.3	186	151	300 × 300	220 × 220	125	20	4-Φ18	4-Φ18	
65	76.1	186	151	300 × 300	220 × 220	145	20	4-Φ18	4-Φ18	
100	108	240	170	350 × 350	251.4 × 251.4	180	20	4-Φ18	8-Φ18	
150	159	360	245	500 × 500	400 × 400	240	37	4-Φ19	8-Φ22	
175	193.7	430	280	500 × 500	400 × 400	275	45	4-Φ19	8-Φ22	
200	219	465	325	500 × 500	400 × 400	295	45	4-Φ19	8-Φ22	
225	245	500	350	700 × 700	520 × 520	345	45	4-Φ28	12-Φ22	
250	273	570	400	700 × 700	520 × 520	350	45	4-Φ28	12-Φ22	
300	323.9	650	480	700 × 700	520 × 520	400	45	4-Φ28	12-Φ22	

Non-standard										
DN	A	L1	L2	D1 × D1	D2 × D2	D3	b	n1 × d1	n2 × d2	
50	60.3	186	151	300 × 300	220 × 220	105	20	4-Φ18	4-Φ14	
65	76.1	186	151	300 × 300	220 × 220	130	20	4-Φ18	4-Φ14	
100	108	240	170	350 × 350	251.4 × 251.4	165	20	4-Φ18	8-Φ18	
150	159	360	245	500 × 500	400 × 400	230	37	4-Φ19	8-Φ18	
200	219	465	325	500 × 500	400 × 400	280	45	4-Φ19	8-Φ22	
250	273	570	400	700 × 700	520 × 520	345	45	4-Φ28	12-Φ22	
300	323.9	650	480	700 × 700	520 × 520	390	45	4-Φ28	12-Φ22	

CAST SS SUBMERSIBLE PUMP

VP SERIES



U-FLO-RELIABLE BRAND!

XI、 UNIT CONVERSION TABLES

Power

Unit	Horsepower	Watt	BTU
1	1.0000	745.7000	42.4300
2	0.0013	1.0000	0.0569
3	0.0236	17.5800	1.0000

Flow Conversion

Unit	U.S. gallon/min	UK gallon/min	acre inch/h	L/sec	L/min	m ³ /h
1	1.0000	0.8330	0.0022	0.0631	3.7850	0.2270
2	1.2000	1.0000	0.0026	0.0757	4.5460	0.2720
3	452.4000	376.9000	1.0000	28.5700	1715.2700	102.7700
4	15.8500	13.2000	0.0350	1.0000	60.0000	3.6000
5	0.2642	0.2200	0.0006	0.0167	1.0000	0.0600
6	4.4000	3.6900	0.0097	0.2778	16667.0000	1.0000

Volume conversion

Unit	cubic inch	gallon	cubic foot	cubic yard	acre foot	liter	cubic meter
1	1.00	0.00	0.00	2.14E-05	1.33E-08	0.02	1.64E-05
2	231.00	1.00	0.13	0.00	3.07E-06	3.79	0.0038
3	1728.00	74805.00	1.00	0.04	0.00	28.32	0.0283
4	46656.00	202.00	27.00	1.00	0.00	764.60	0.7646
5	75270000.0	325892.0	43592.0	1613.0	1.0	1233000.0	1233.0000
6	61.020	0.264	0.035	0.001	8.11E-07	1.000	0.0010
7	61023.000	264.200	35.310	1.308	0.001	1000.000	1.0000

Length Conversion

Unit	inch	foot	yard	mile	mm	cm	m	km
1	1.0	0.1	0.0	1.58E-05	25.4	2.5	0.0	2.54E05
2	12.0	1.0	0.3	0.0	304.8	30.5	0.3	0.00031
3	36.0	3.0	1.0	0.0	914.4	91.4	0.9	0.00091
4	6336.0	5280.0	1760.0	1.0	16093444.0	160934.4	1609.3	1.60940
5	0.0	0.0	0.0	6.21E-07	1.0	0.1	0.0	0.00001
6	0.4	0.0	0.0	6121E-06	10.0	1.0	0.0	0.00001
7	39.4	3.3	1.1	0.0	100.0	100.0	1.0	0.00100
8	39370.0	3280.8	1093.6	0.6	1000000.0	100000.0	-	1.00000

Pressure Conversion

Unit	-	foot	m	Kg/cm ³	Kpa	bar
1	1.000	2.310	0.0703	0.070	6.895	0.069
2	0.434	1.000	0.305	0.031	2.984	0.030
3	1.422	3.281	1.000	0.100	9.804	0.098
4	14.220	32.810	10.000	1.000	98.040	0.980
5	0.145	0.335	0.102	0.010	1.000	1.010
6	14.500	33.520	10.200	1.020	100.000	1.000

Fahrenheit degree 32.0 212.0 F=C9/5+32

Celsius degree 0.0 100.0 C= (F-32) 5/9

